

LMF25L UU SAMICK

Linear bushing

TYPE: Shaft guidance systems, Linear bushing, With flange, Circular type, double length, Type LMF..L, Asian standard, Plastic cage (SAMICK)

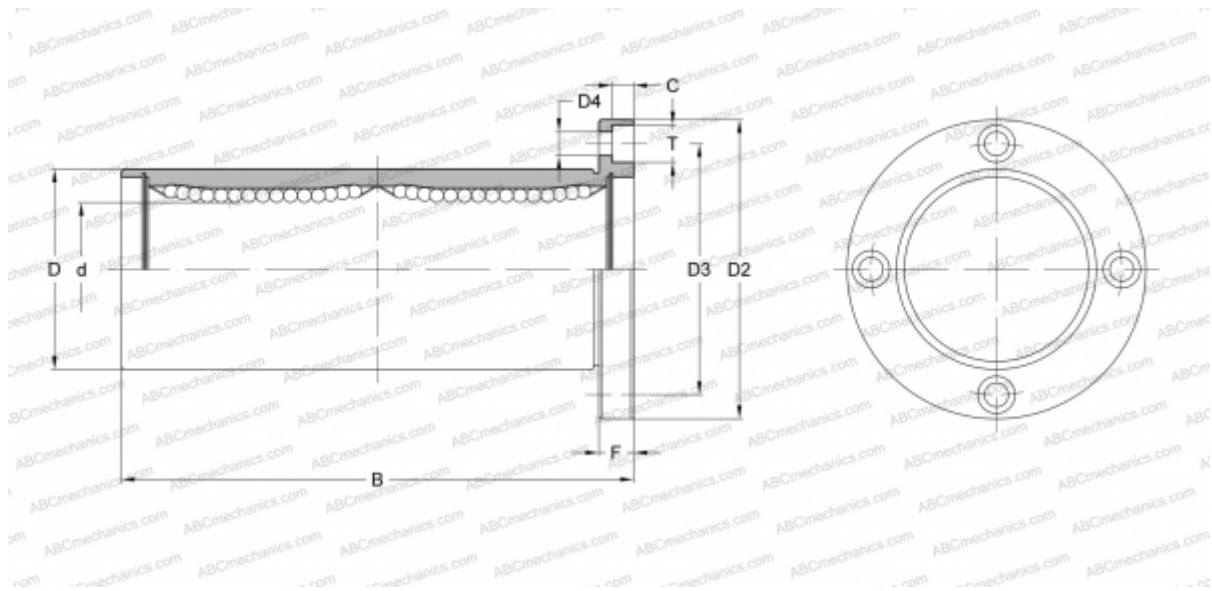

Technical specification

DIMENSIONS, MM

d	25,000
D	40,000
B	112,000
D2	62,000
D3	51,000
D4	5,500
T	9,500
C	5,400
F	8

WEIGHT, KG 0,515

MANUFACTURER [SAMICK](http://www.samick.com)