

LMEK8 UU SAMICK

Linear bushing

TYPE: Shaft guidance systems, Linear bushing, With flange, Square type, Type LMEK, European standard, Plastic cage (SAMICK)

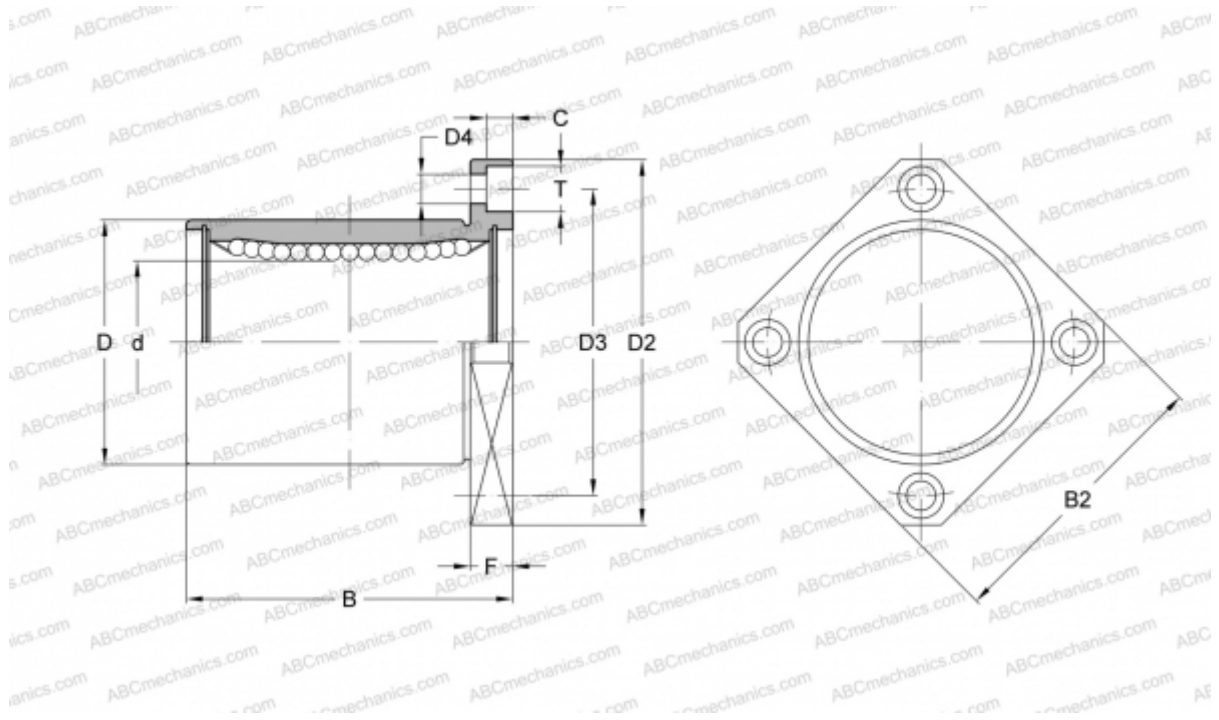

Technical specification

DIMENSIONS, MM

d	8,000
D	16,000
B	25,000
D2	32,000
D3	24,000
D4	3,400
B2	25,000
T	6,500
C	3,300
F	5

WEIGHT, KG 0,044

MANUFACTURER [SAMICK](#)