

LMEK25 UU SAMICK

Linear bushing

TYPE: Shaft guidance systems, Linear bushing, With flange, Square type, Type LMEK, European standard, Plastic cage (SAMICK)

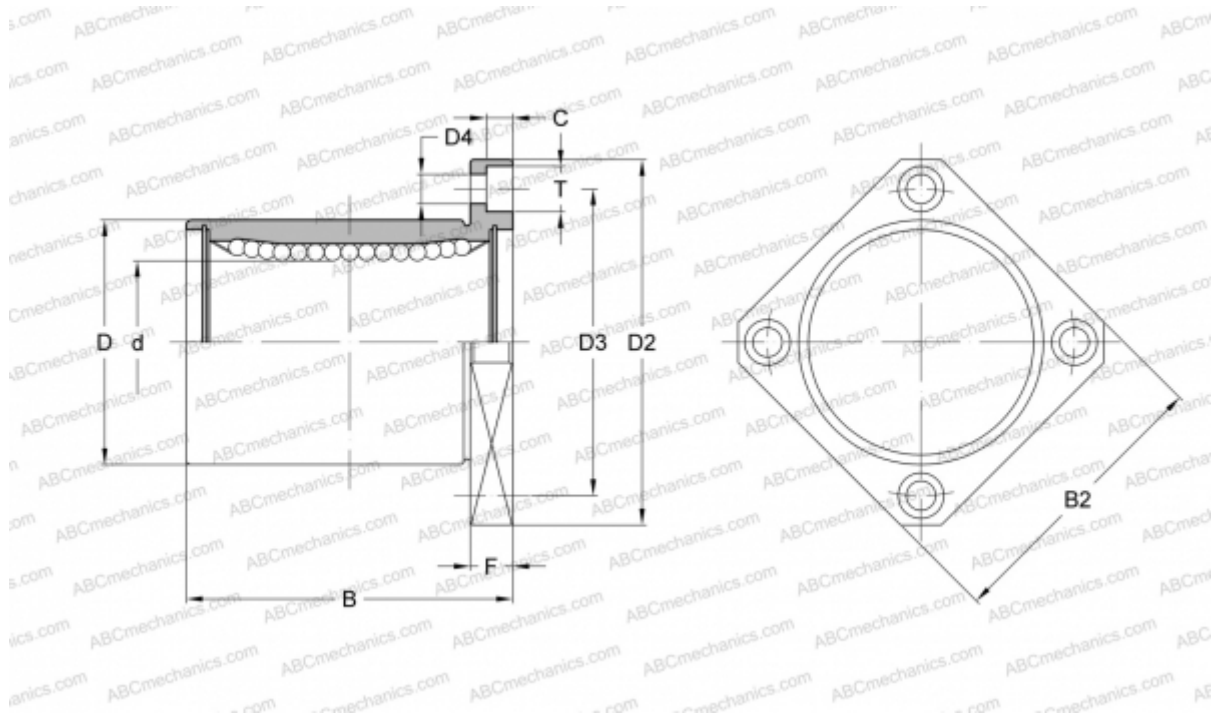

Technical specification

DIMENSIONS, MM

d	25,000
D	40,000
B	58,000
D2	62,000
D3	51,000
D4	5,500
B2	50,000
T	9,500
C	5,400
F	8

WEIGHT, KG 0,335

MANUFACTURER [SAMICK](#)