

## LMK12 UU SAMICK

Linear bushing

TYPE: Shaft guidance systems, Linear bushing, With flange, Square type, Type LMK, Asian standard, Plastic cage (SAMICK)

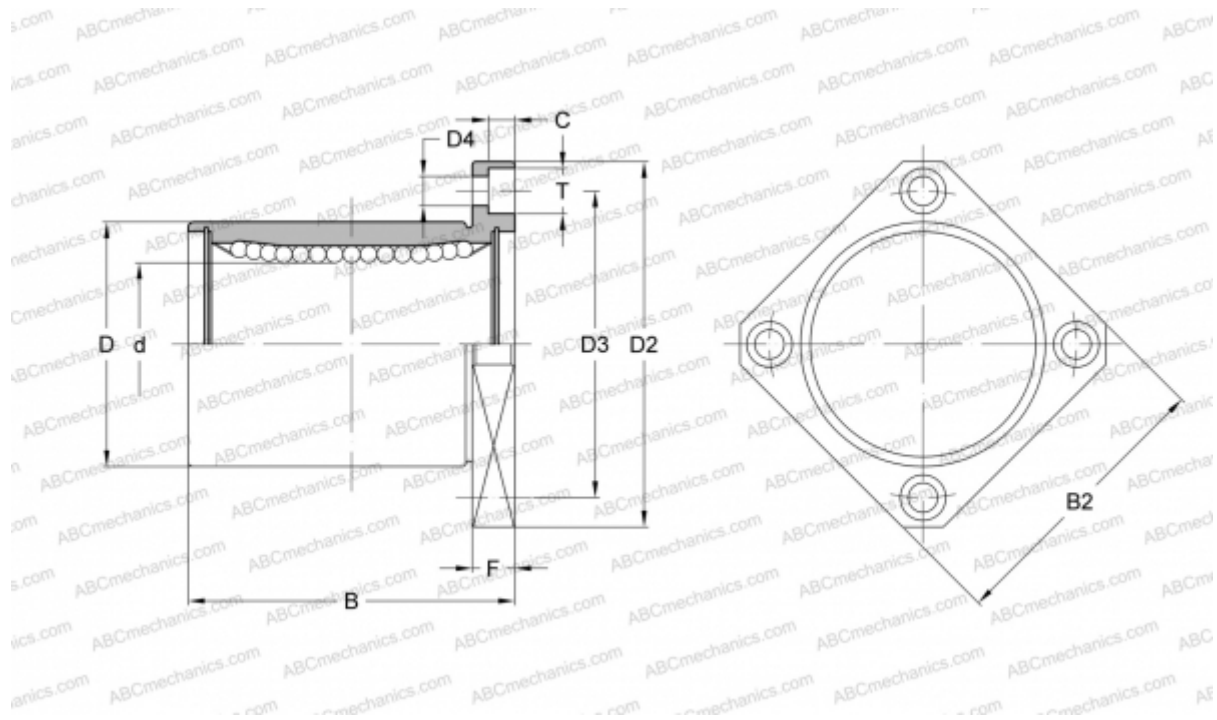

### Technical specification

#### DIMENSIONS, MM

d	12,000
D	21,000
B	30,000
D2	42,000
D3	32,000
D4	4,500
B2	32,000
T	8,000
C	4,400
F	6

**WEIGHT, KG** 0,076

**MANUFACTURER** [SAMICK](#)