

## LMK20 UU SAMICK

Linear bushing

TYPE: Shaft guidance systems, Linear bushing, With flange, Square type, Type LMK, Asian standard, Plastic cage (SAMICK)

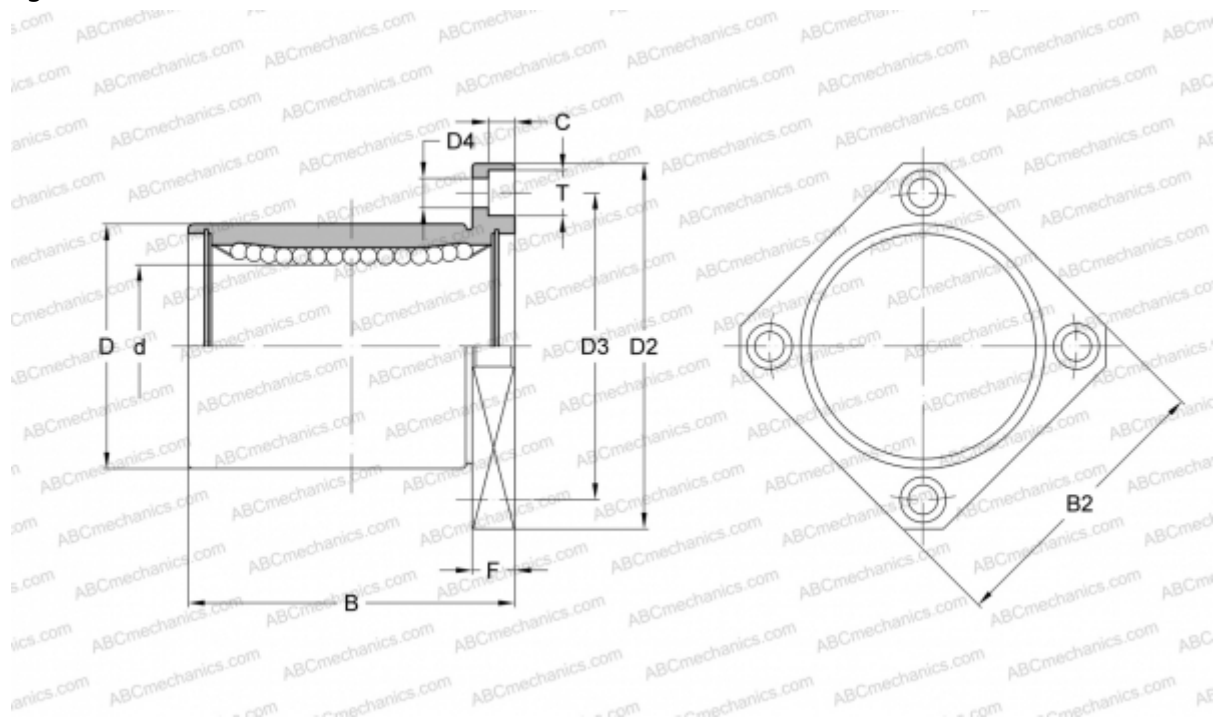

### Technical specification

#### DIMENSIONS, MM

d	20,000
D	32,000
B	42,000
D2	54,000
D3	43,000
D4	5,500
B2	42,000
T	9,500
C	5,400
F	8

**WEIGHT, KG** 0,180

**MANUFACTURER** [SAMICK](#)