

## LMK40 UU SAMICK

Linear bushing

TYPE: Shaft guidance systems, Linear bushing, With flange, Square type, Type LMK, Asian standard, Plastic cage (SAMICK)

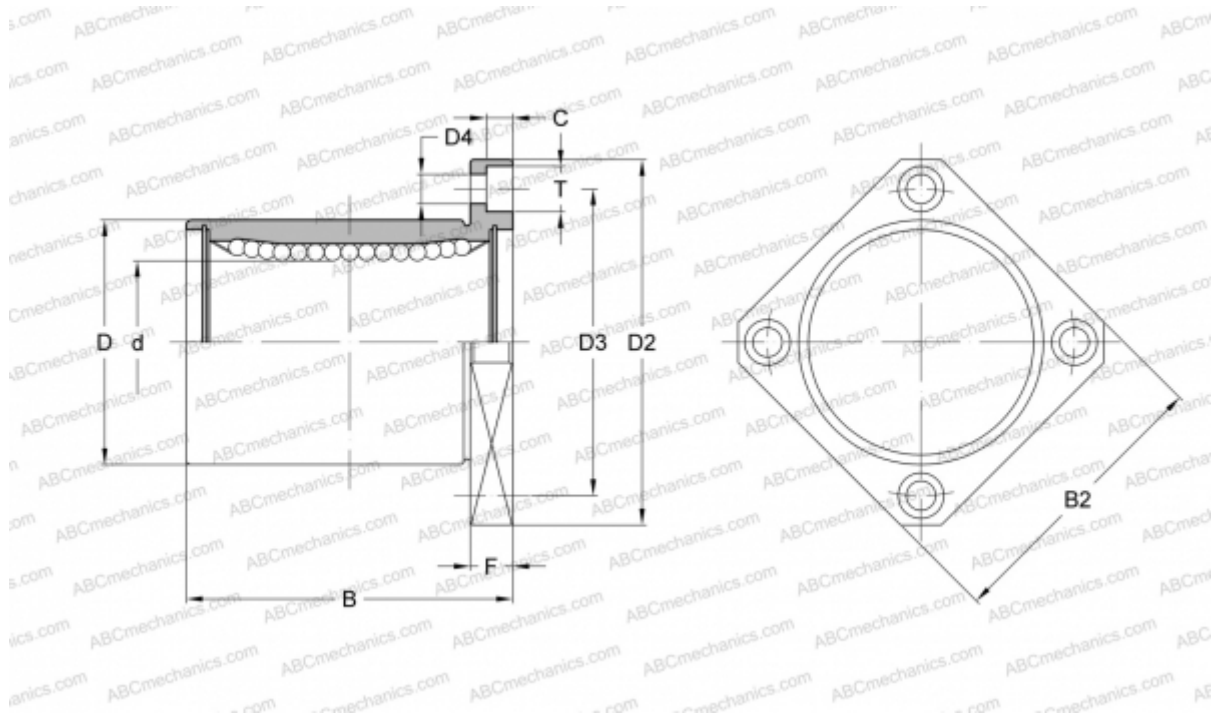

### Technical specification

#### DIMENSIONS, MM

d	40,000
D	60,000
B	80,000
D2	96,000
D3	78,000
D4	9,000
B2	75,000
T	14,000
C	8,600
F	13

**WEIGHT, KG** 1,054

**MANUFACTURER** [SAMICK](#)