

## LMK60 UU SAMICK

Linear bushing

TYPE: Shaft guidance systems, Linear bushing, With flange, Square type, Type LMK, Asian standard, Plastic cage (SAMICK)

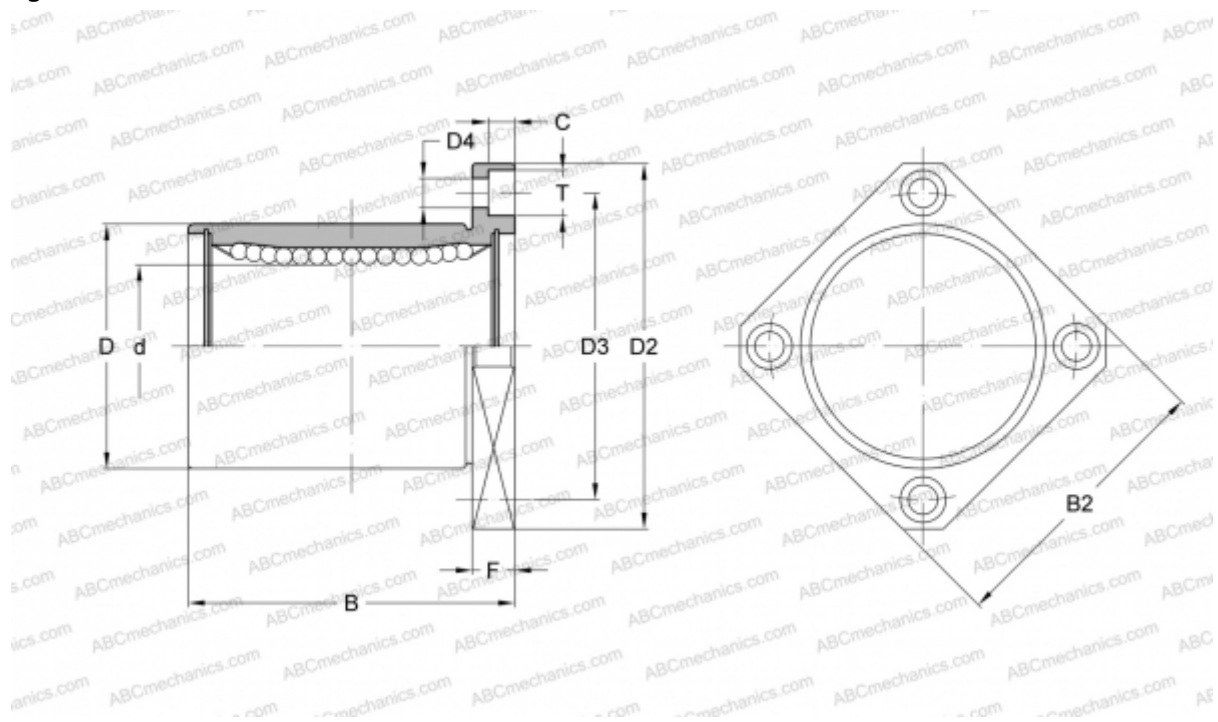

### Technical specification

#### DIMENSIONS, MM

d	60,000
D	90,000
B	110,000
D2	134,000
D3	112,000
D4	11,000
B2	106,000
T	17,500
C	10,800
F	18

**WEIGHT, KG** 2,960

**MANUFACTURER** [SAMICK](#)