

## LMK6L UU SAMICK

Linear bushing

TYPE: Shaft guidance systems, Linear bushing, With flange, Square type, double length, Type LMK..L, Asian standard, Plastic cage (SAMICK)

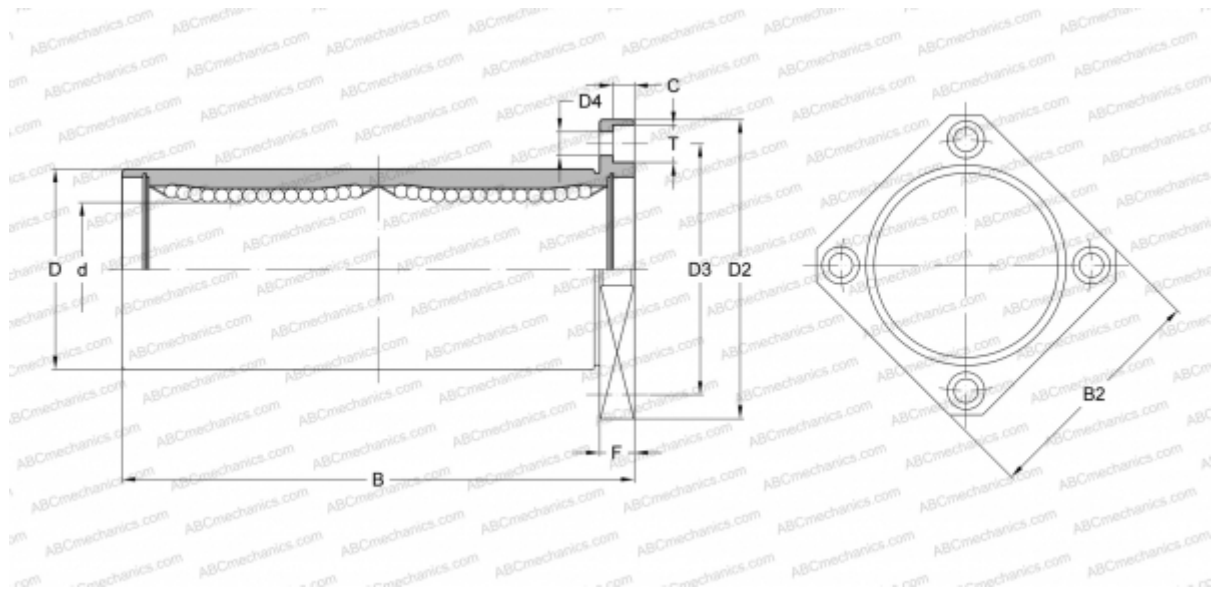

### Technical specification

#### DIMENSIONS, MM

d	6,000
D	12,000
B	35,000
D2	28,000
D3	20,000
D4	3,400
B2	22,000
T	6,500
C	3,300
F	5

**WEIGHT, KG** 0,031

**MANUFACTURER** [SAMICK](#)