

LMH20 UU A SAMICK

Linear bushing

TYPE: Shaft guidance systems, Linear bushing, With flange, Oval type, Type LMH, Asian standard, Steel cage (SAMICK)

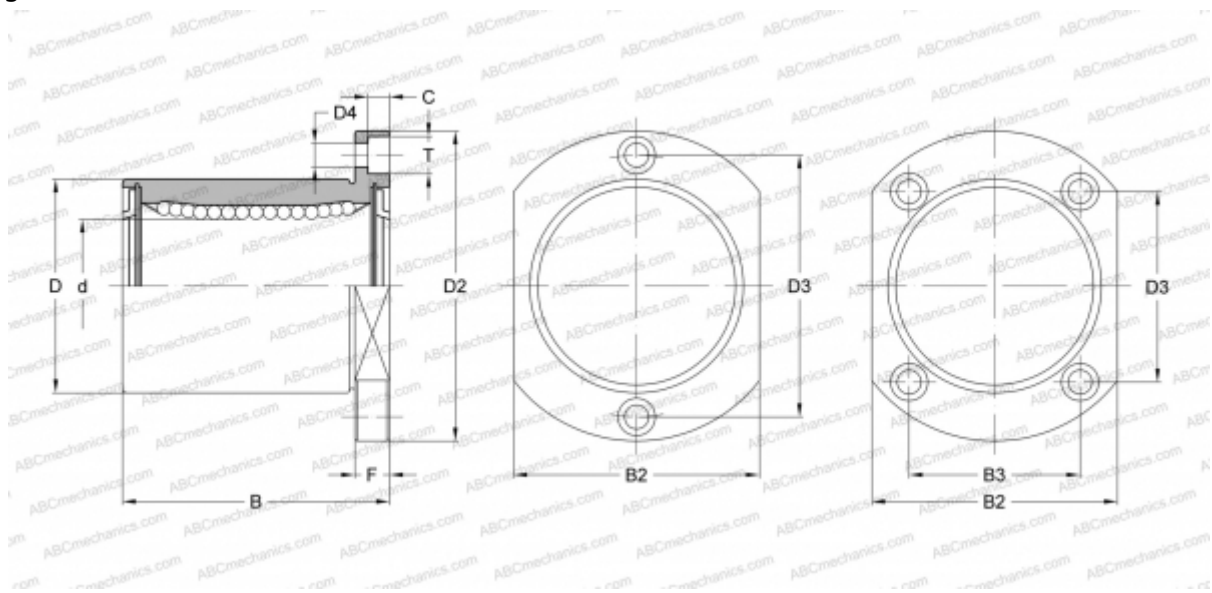

Technical specification

DIMENSIONS, MM

d	20,000
D	32,000
B	42,000
D2	54,000
D3	36,000
D4	5,500
B2	38,000
B3	24,000
T	9,500
C	5,400
F	8

WEIGHT, KG 0,180

MANUFACTURER [SAMICK](#)