

LMH6L UU SAMICK

Linear bushing

TYPE: Shaft guidance systems, Linear bushing, With flange, Oval type, double length, Type LMH..L, Asian standard, Plastic cage (SAMICK)

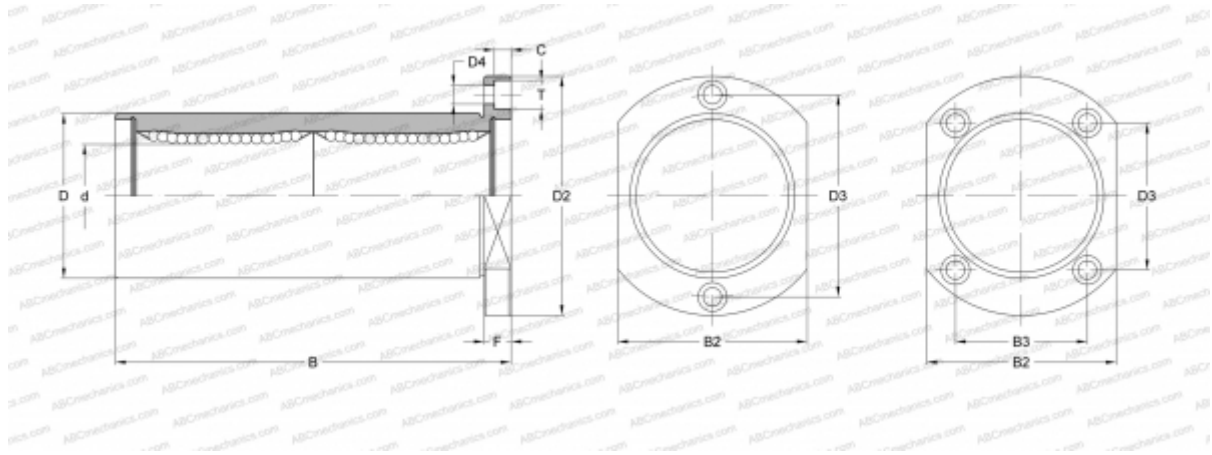

Technical specification

DIMENSIONS, MM

d	6,000
D	12,000
B	35,000
D2	28,000
D3	20,000
D4	3,400
B2	18,000
T	6,500
C	3,300
F	5

WEIGHT, KG 0,031

MANUFACTURER [SAMICK](#)