

LMH13L UU A SAMICK

Linear bushing

TYPE: Shaft guidance systems, Linear bushing, With flange, Oval type, double length, Type LMH..L, Asian standard, Steel cage (SAMICK)

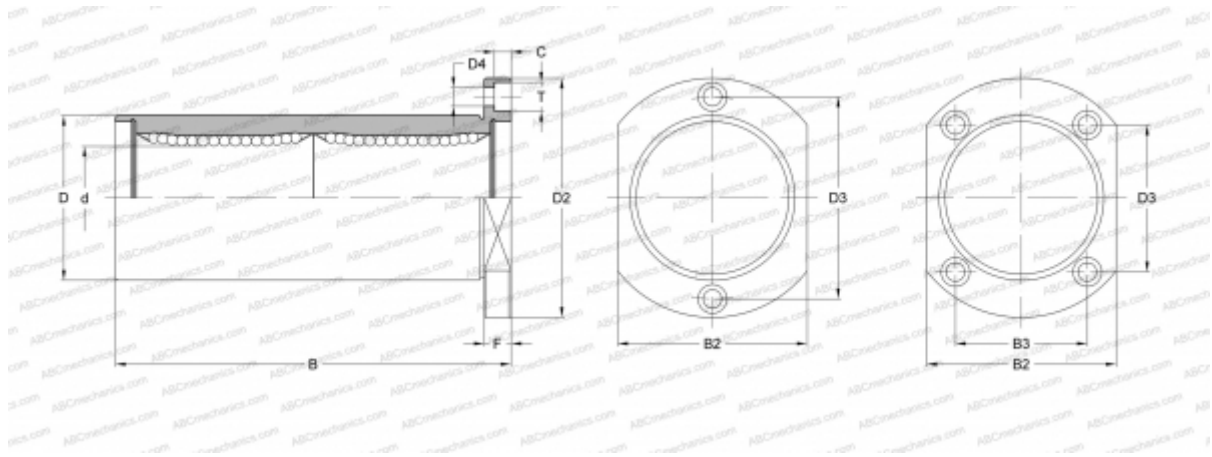

Technical specification

DIMENSIONS, MM

d	13,000
D	23,000
B	61,000
D2	43,000
D3	33,000
D4	4,500
B2	29,000
T	8,000
C	4,400
F	6

WEIGHT, KG 130,000

MANUFACTURER [SAMICK](#)