

## LMEFP40 UU SAMICK

Linear bushing

TYPE: Shaft guidance systems, Linear bushing, Pilot flange location, Circular type, Type LMEFP, European standard, Plastic cage (SAMICK)

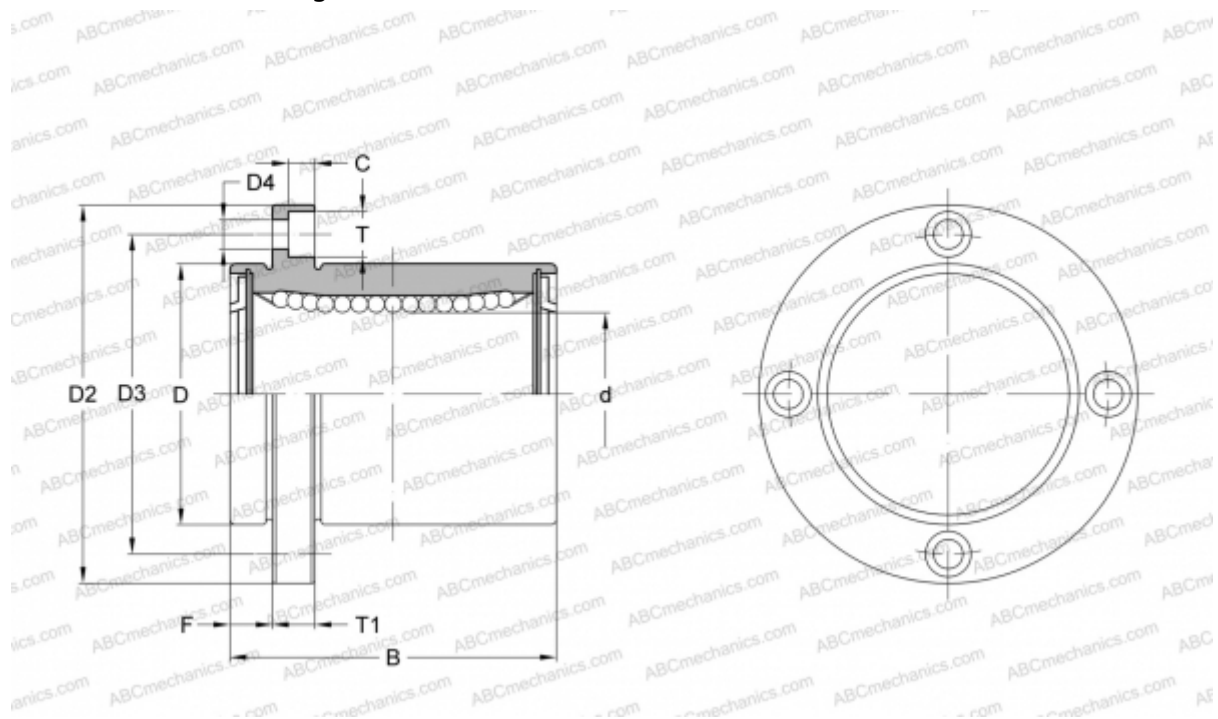

### Technical specification

#### DIMENSIONS, MM

d	40,000
D	62,000
B	80,000
D2	98,000
D3	80,000
D4	9,000
T	14,000
T1	13,000
C	8,600
F	13

**WEIGHT, KG** 1,185

**MANUFACTURER** [SAMICK](http://www.samick.com)