

## LMEFP8L UU SAMICK

Linear bushing

TYPE: Shaft guidance systems, Linear bushing, Pilot flange location, Circular type, double length, Type LMEFP..L, European standard, Plastic cage (SAMICK)

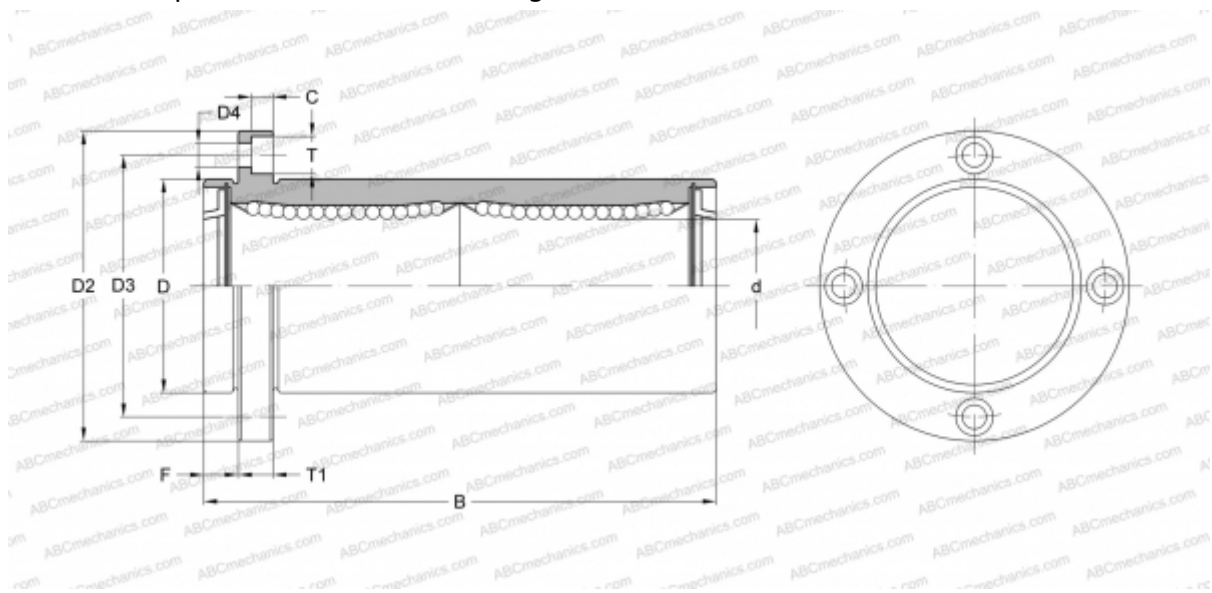

### Technical specification

#### DIMENSIONS, MM

d	8,000
D	16,000
B	45,000
D2	32,000
D3	24,000
D4	3,400
T	6,500
T1	5,000
C	3,300
F	5

**WEIGHT, KG** 0,053

**MANUFACTURER** [SAMICK](http://www.samick.com)