

LMEFP30L UU SAMICK

Linear bushing

TYPE: Shaft guidance systems, Linear bushing, Pilot flange location, Circular type, double length, Type LMEFP..L, European standard, Plastic cage (SAMICK)

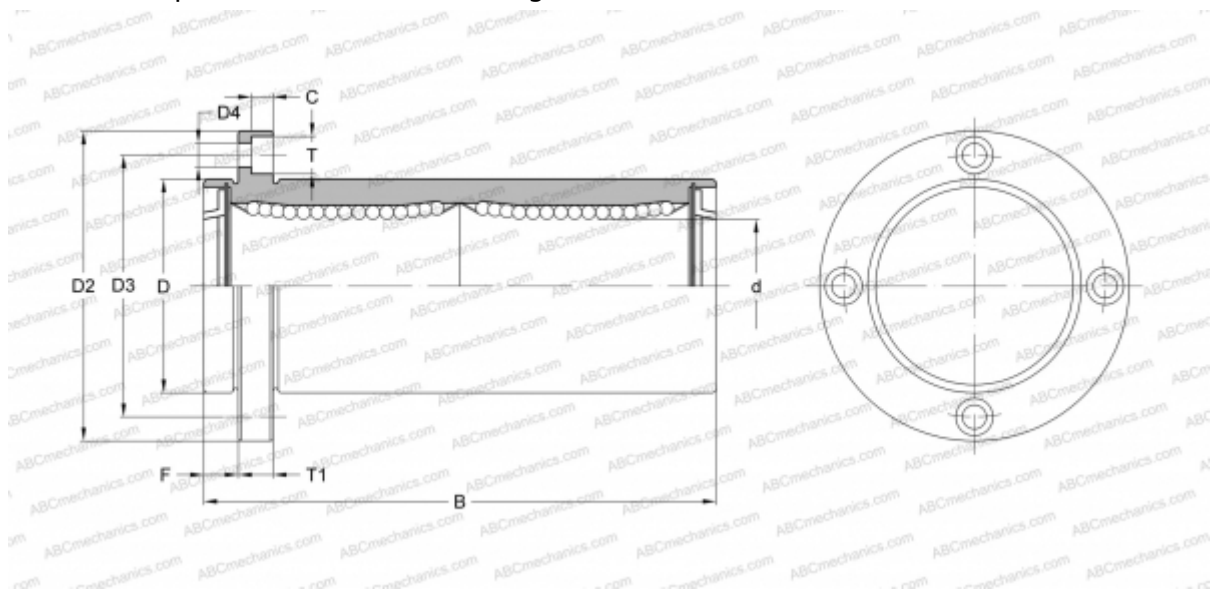

Technical specification

DIMENSIONS, MM

d	30,000
D	47,000
B	123,000
D2	76,000
D3	62,000
D4	6,600
T	11,000
T1	10,000
C	6,500
F	10

WEIGHT, KG 0,655

MANUFACTURER [SAMICK](http://www.samick.com)