

LMEFP50L UU SAMICK

Linear bushing

TYPE: Shaft guidance systems, Linear bushing, Pilot flange location, Circular type, double length, Type LMEFP..L, European standard, Plastic cage (SAMICK)

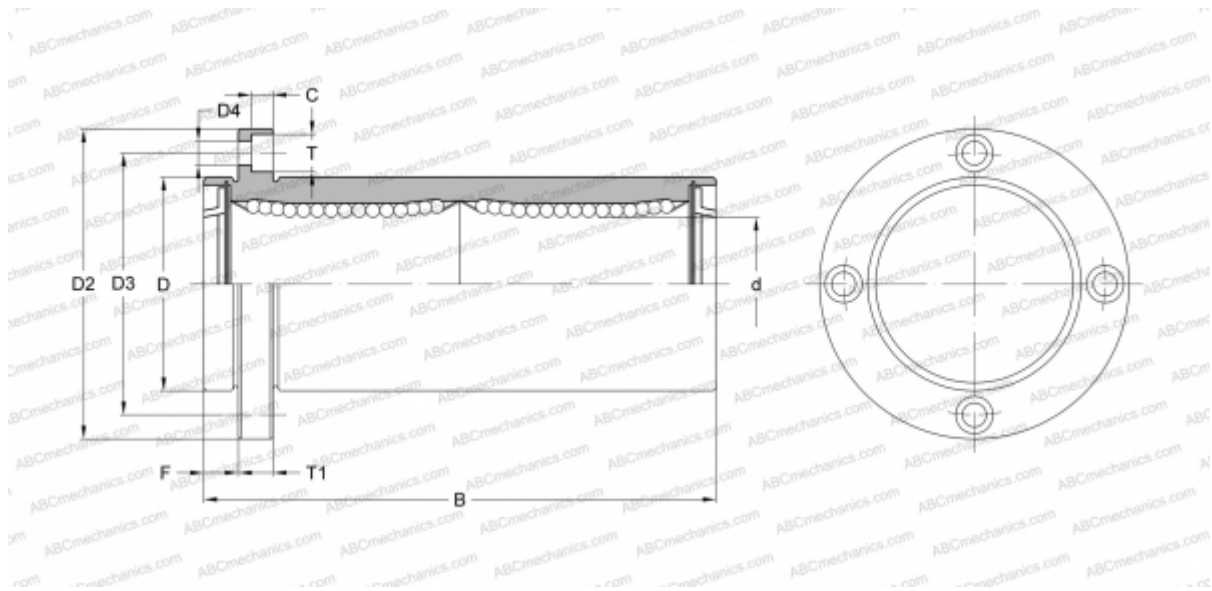

Technical specification

DIMENSIONS, MM

d	50,000
D	75,000
B	192,000
D2	112,000
D3	94,000
D4	9,000
T	14,000
T1	13,000
C	8,600
F	13

WEIGHT, KG 3,500

MANUFACTURER [SAMICK](http://www.samick.com)