

## LMEFP16L UU A SAMICK

Linear bushing

TYPE: Shaft guidance systems, Linear bushing, Pilot flange location, Circular type, double length, Type LMEFP..L, European standard, Steel cage (SAMICK)

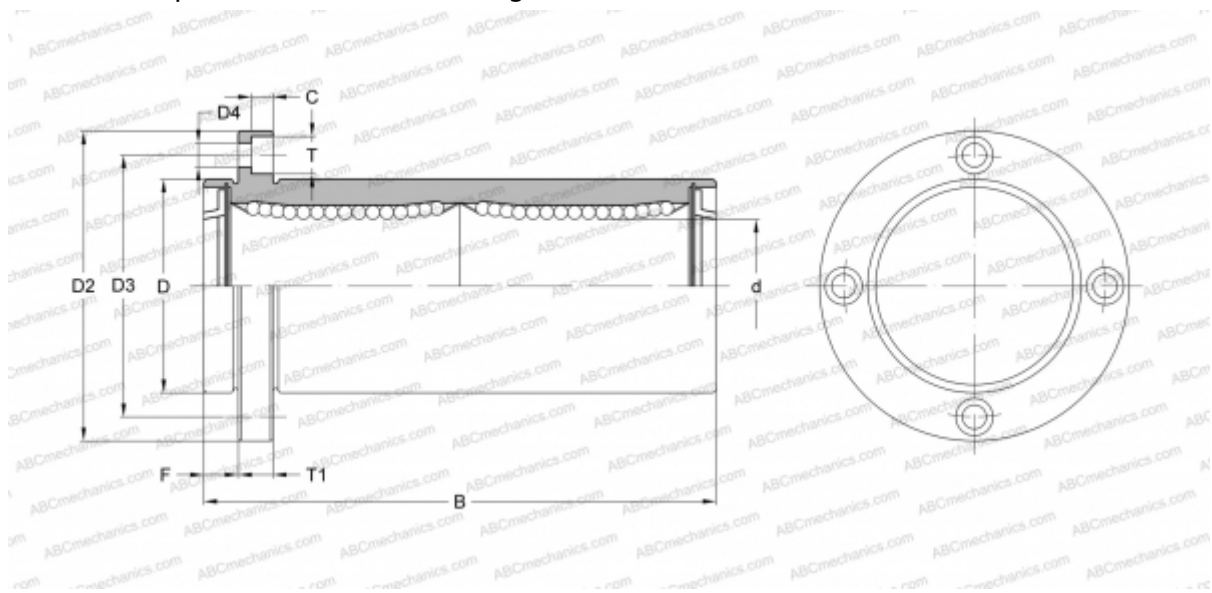

### Technical specification

#### DIMENSIONS, MM

d	16,000
D	26,000
B	70,000
D2	46,000
D3	36,000
D4	4,500
T	8,000
T1	6,000
C	4,400
F	6

**WEIGHT, KG** 0,187

**MANUFACTURER** [SAMICK](http://www.samick.com)