

## LMFP13L UU SAMICK

Linear bushing

TYPE: Shaft guidance systems, Linear bushing, Pilot flange location, Circular type, double length, Type LMFP..L, Asian standard, Plastic cage (SAMICK)

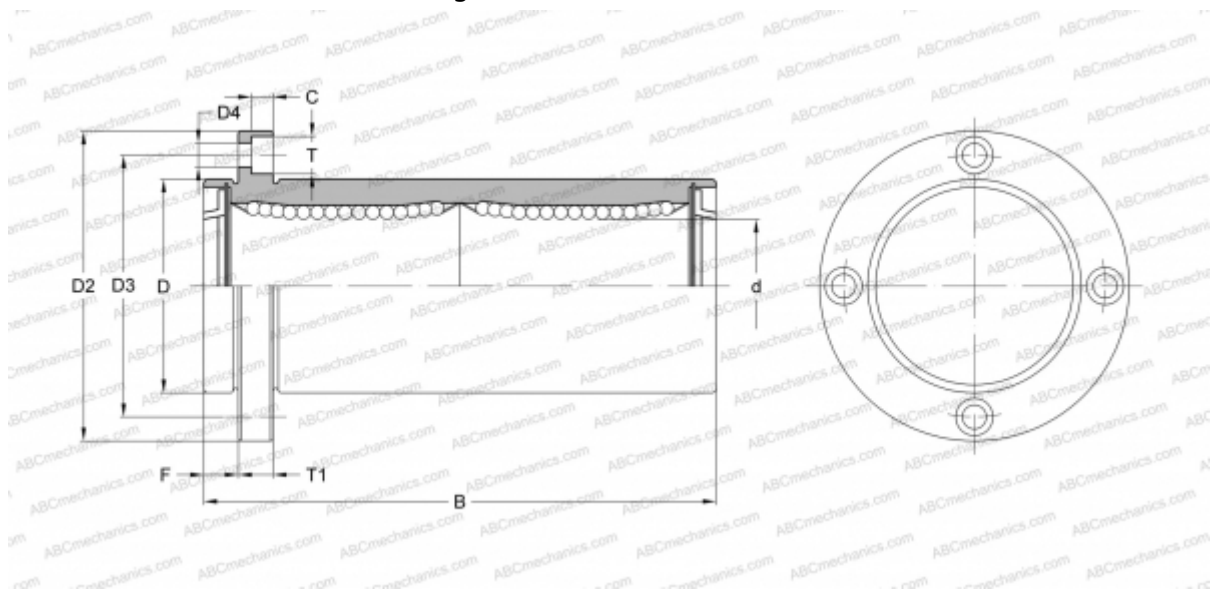

### Technical specification

#### DIMENSIONS, MM

d	13,000
D	23,000
B	61,000
D2	43,000
D3	33,000
D4	4,500
T	8,000
T1	6,000
C	4,400
F	6

**WEIGHT, KG** 0,130

**MANUFACTURER** [SAMICK](http://www.samick.com)