

LMFP35L UU SAMICK

Linear bushing

TYPE: Shaft guidance systems, Linear bushing, Pilot flange location, Circular type, double length, Type LMFP..L, Asian standard, Plastic cage (SAMICK)

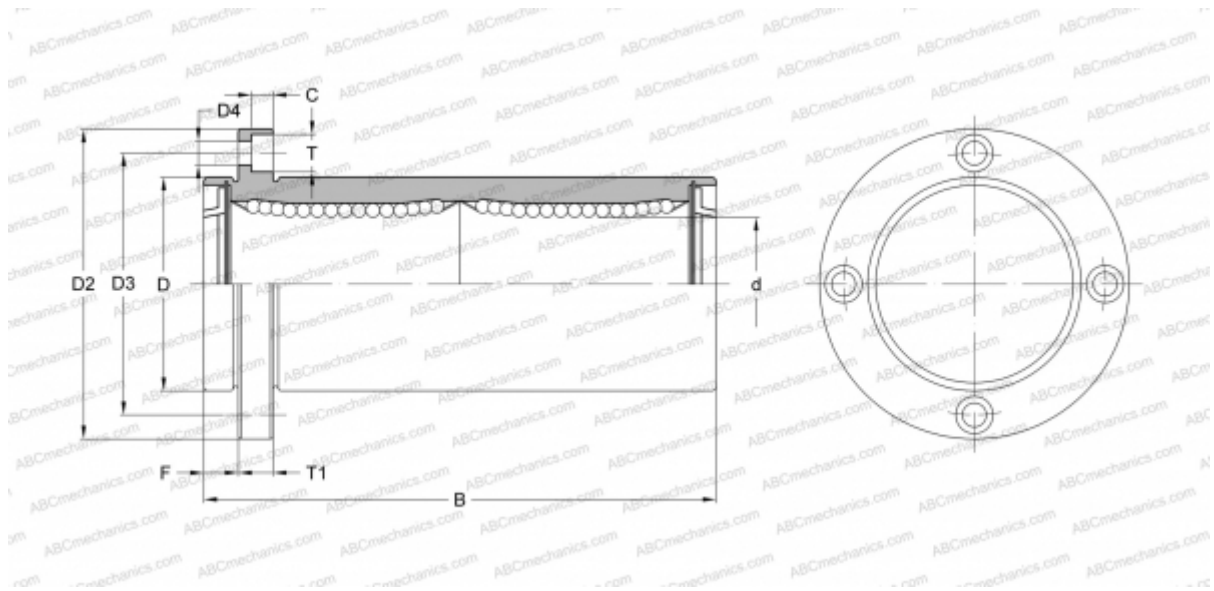

Technical specification

DIMENSIONS, MM

d	35,000
D	52,000
B	135,000
D2	82,000
D3	67,000
D4	6,600
T	11,000
T1	10,000
C	6,500
F	10

WEIGHT, KG 0,970

MANUFACTURER [SAMICK](http://www.samick.com)