

## LMKP12L UU SAMICK

Linear bushing

TYPE: Shaft guidance systems, Linear bushing, Pilot flange location, Square type, double length, Type LMKP..L, Asian standard, Plastic cage (SAMICK)

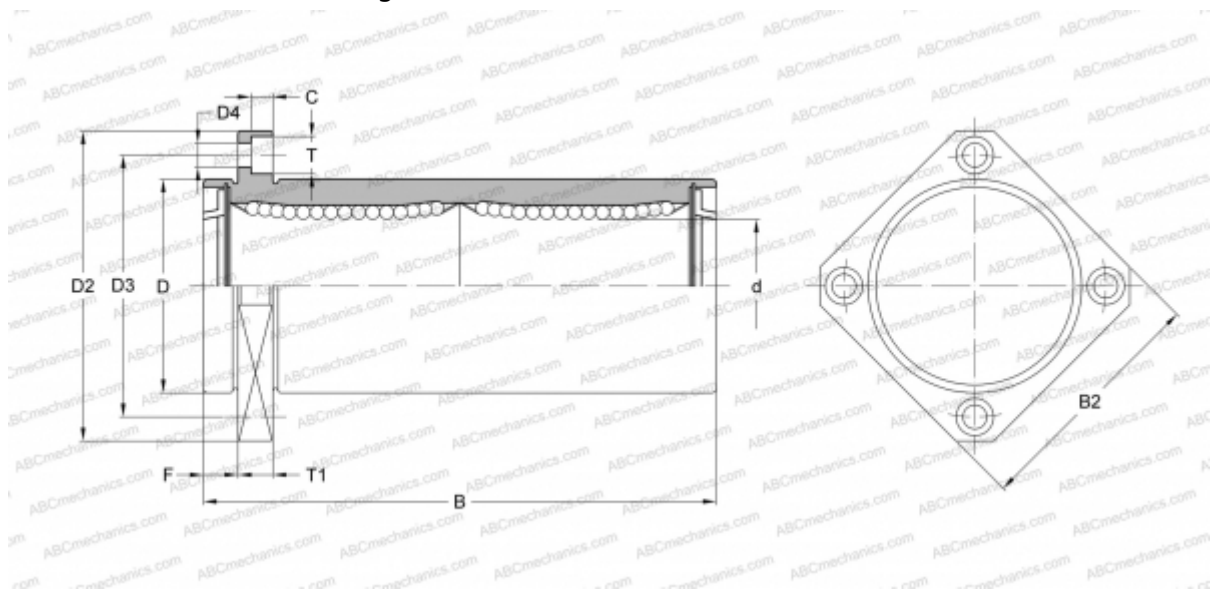

### Technical specification

#### DIMENSIONS, MM

d	12,000
D	21,000
B	57,000
D2	42,000
D3	32,000
D4	4,500
B2	32,000
T	8,000
T1	6,000
C	4,400
F	6

**WEIGHT, KG** 0,100

**MANUFACTURER** [SAMICK](#)