

## LMHP8 UU SAMICK

Linear bushing

TYPE: Shaft guidance systems, Linear bushing, Pilot flange location, Oval type, Type LMHP, Asian standard, Plastic cage (SAMICK)

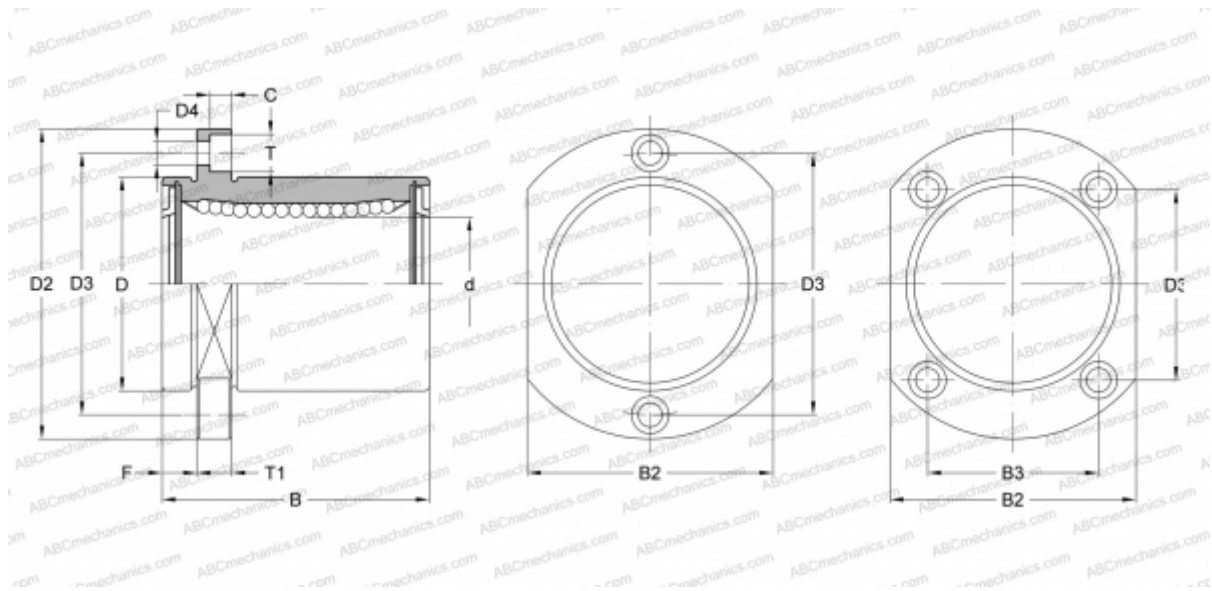

### Technical specification

#### DIMENSIONS, MM

d	8,000
D	15,000
B	24,000
D2	32,000
D3	24,000
D4	3,400
B2	21,000
T	6,500
T1	5,000
C	3,300
F	5

**WEIGHT, KG** 0,040

**MANUFACTURER** [SAMICK](#)