

## LMHP25L UU SAMICK

Linear bushing

TYPE: Shaft guidance systems, Linear bushing, Pilot flange location, Oval type, double length, Type LMHP..L, Asian standard, Plastic cage (SAMICK)

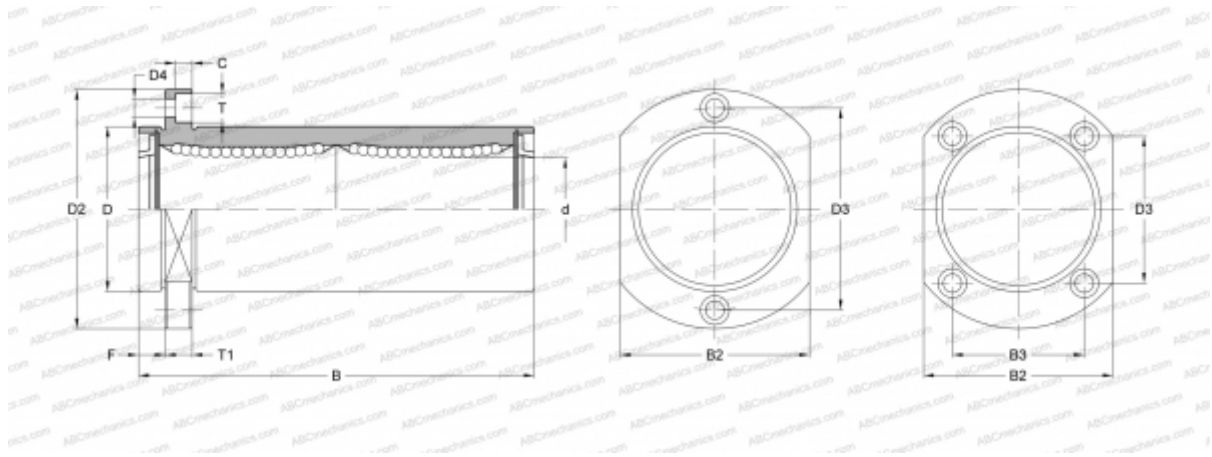

### Technical specification

#### DIMENSIONS, MM

d	25,000
D	40,000
B	112,000
D2	62,000
D3	40,000
D4	5,500
B2	46,000
B3	32,000
T	9,500
T1	8,000
C	5,400
F	8

**WEIGHT, KG** 0,515

**MANUFACTURER** [SAMICK](#)