

LMEFM16 UU SAMICK

Linear bushing

TYPE: Shaft guidance systems, Linear bushing, Middle flange location, Circular type, Type LMEFM, European standard, Plastic cage (SAMICK)

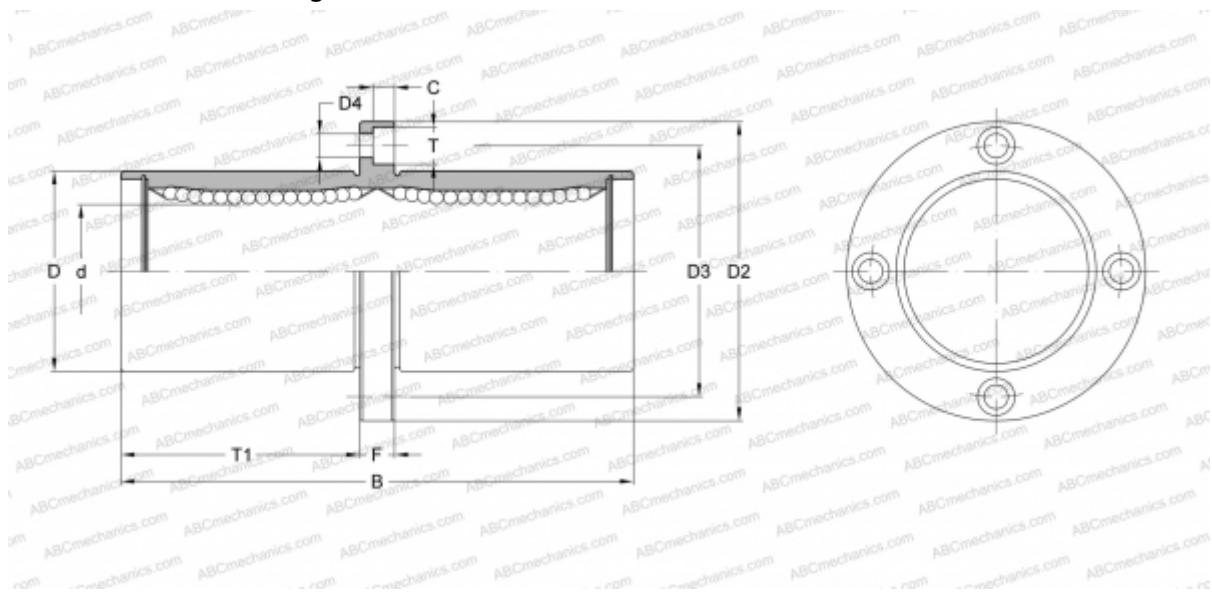

Technical specification

DIMENSIONS, MM

d	16,000
D	26,000
B	70,000
D2	46,000
D3	36,000
D4	4,500
T	8,000
T1	32,000
C	4,400
F	6

WEIGHT, KG 0,187

MANUFACTURER [SAMICK](http://www.samick.com)