

LMFM40 UU SAMICK

Linear bushing

TYPE: Shaft guidance systems, Linear bushing, Middle flange location, Circular type, Type LMFM, Asian standard, Plastic cage (SAMICK)

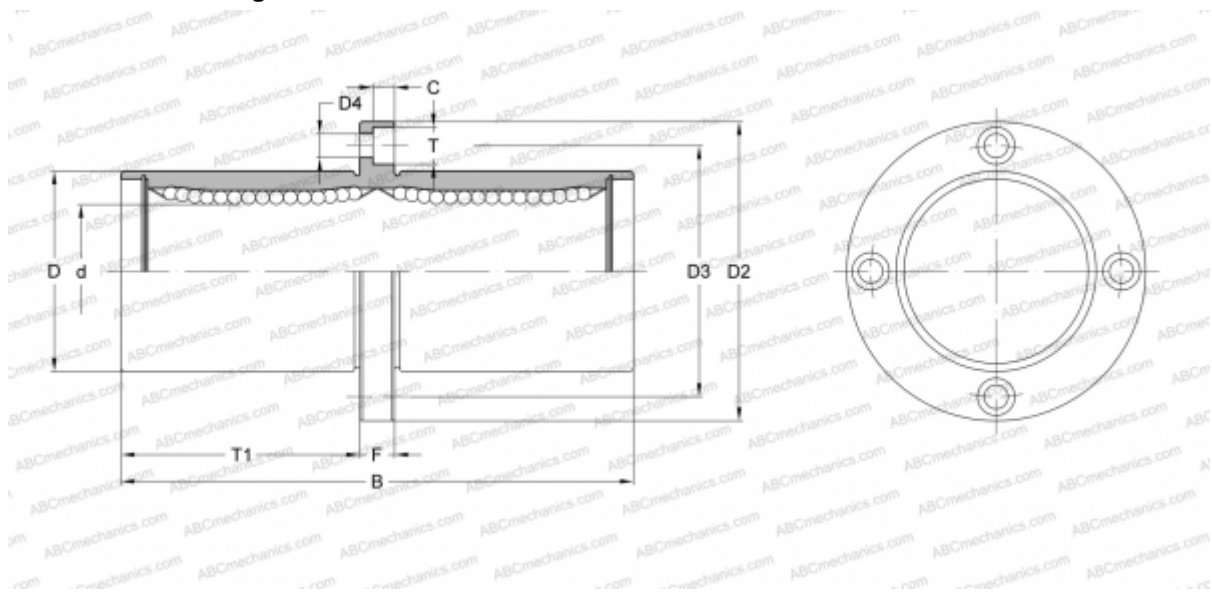

Technical specification

DIMENSIONS, MM

d	40,000
D	60,000
B	154,000
D2	96,000
D3	78,000
D4	9,000
T	14,000
T1	70,500
C	8,600
F	13

WEIGHT, KG 1,560

MANUFACTURER [SAMICK](http://www.samick.com)