

## LMFM12 UU A SAMICK

Linear bushing

TYPE: Shaft guidance systems, Linear bushing, Middle flange location, Circular type, Type LMFM, Asian standard, Steel cage (SAMICK)

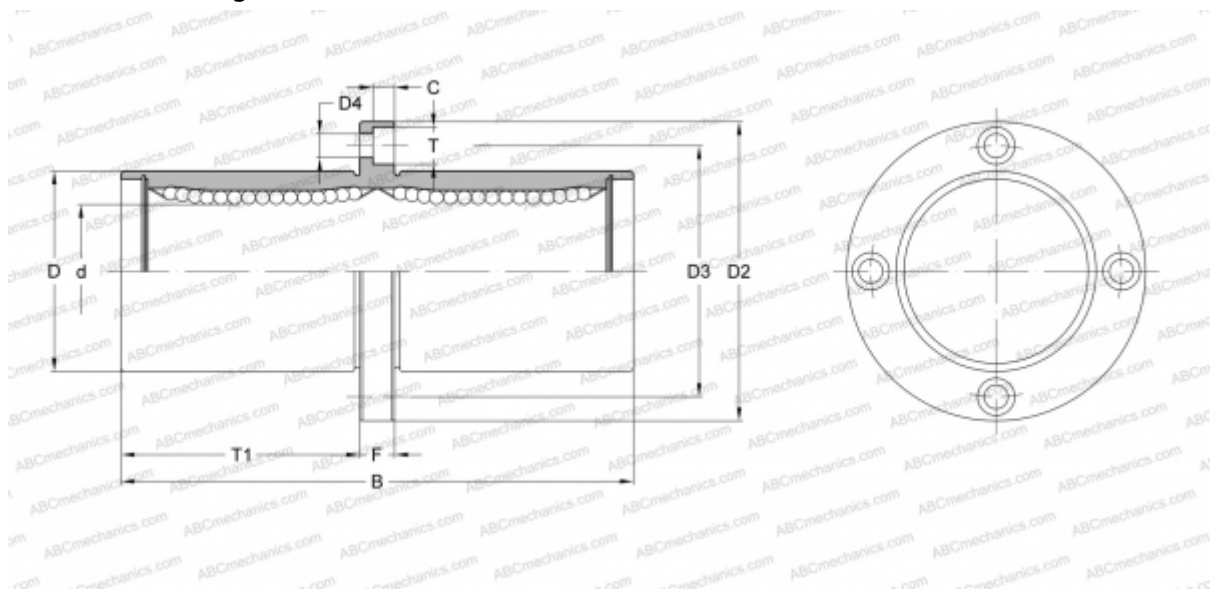

### Technical specification

#### DIMENSIONS, MM

d	12,000
D	21,000
B	57,000
D2	42,000
D3	32,000
D4	4,500
T	8,000
T1	25,500
C	4,400
F	6

**WEIGHT, KG** 0,100

**MANUFACTURER** [SAMICK](http://www.samick.com)