

## LMFM16 UU A SAMICK

Linear bushing

TYPE: Shaft guidance systems, Linear bushing, Middle flange location, Circular type, Type LMFM, Asian standard, Steel cage (SAMICK)

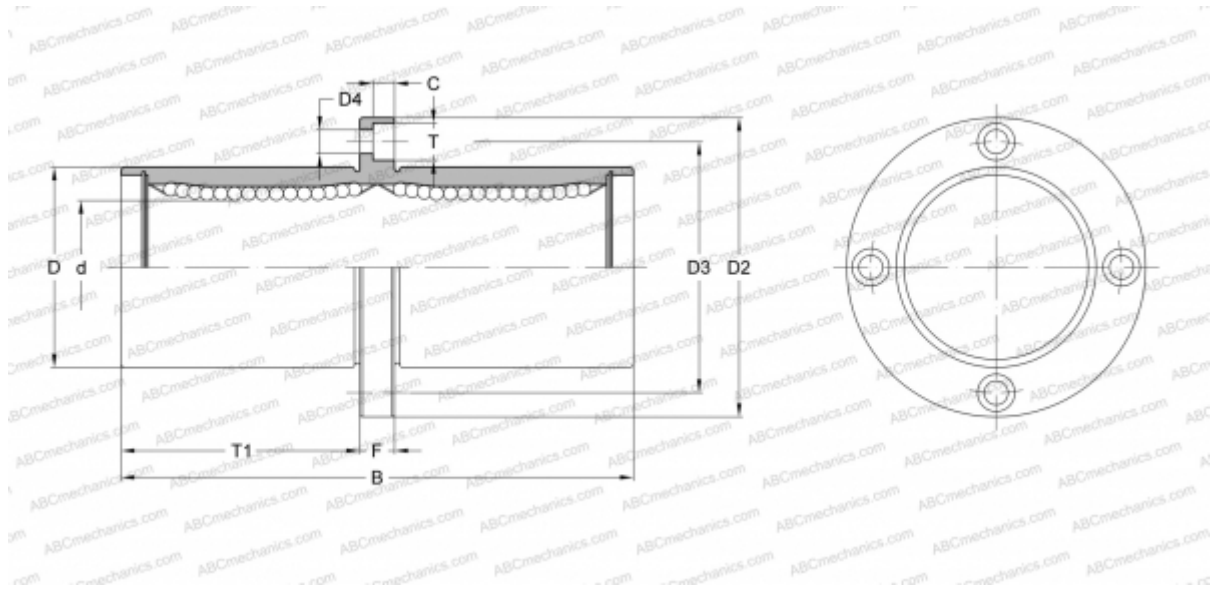

### Technical specification

#### DIMENSIONS, MM

d	16,000
D	28,000
B	70,000
D2	48,000
D3	38,000
D4	4,500
T	8,000
T1	32,000
C	4,400
F	6

**WEIGHT, KG** 0,187

**MANUFACTURER** [SAMICK](http://www.samick.com)