

LMKM16 UU SAMICK

Linear bushing

TYPE: Shaft guidance systems, Linear bushing, Middle flange location, Square type, Type LMKM, Asian standard, Plastic cage (SAMICK)

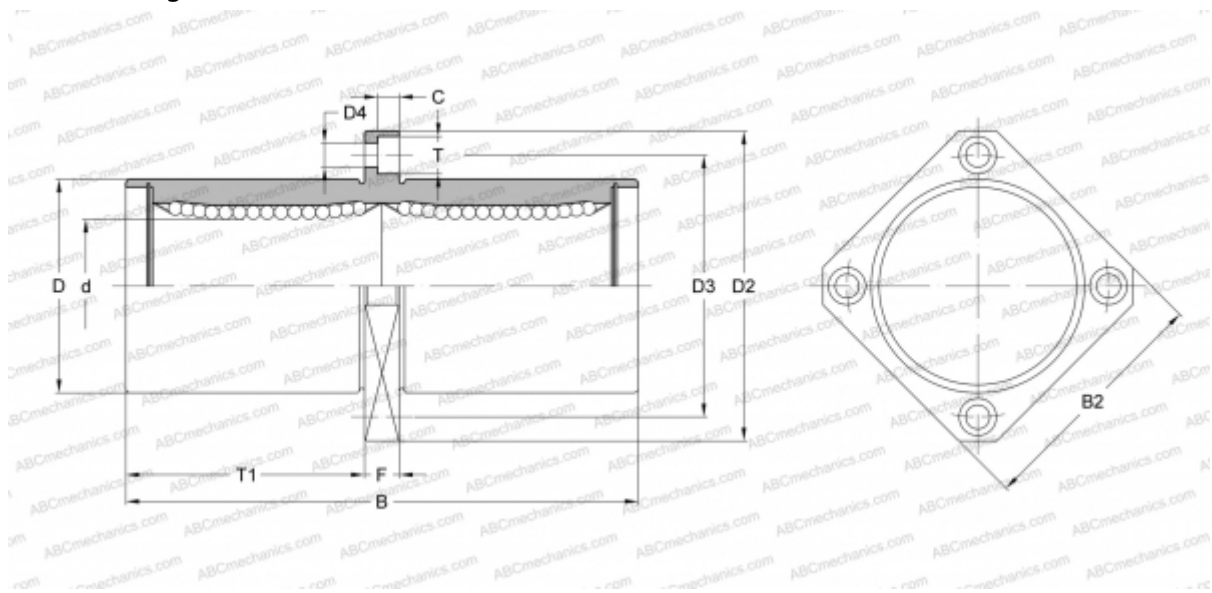

Technical specification

DIMENSIONS, MM

d	16,000
D	28,000
B	70,000
D2	48,000
D3	38,000
D4	4,500
B2	37,000
T	8,000
T1	32,000
C	4,400
F	6

WEIGHT, KG 0,187

MANUFACTURER [SAMICK](#)