

LMKM8 UU A SAMICK

Linear bushing

TYPE: Shaft guidance systems, Linear bushing, Middle flange location, Square type, Type LMKM, Asian standard, Steel cage (SAMICK)

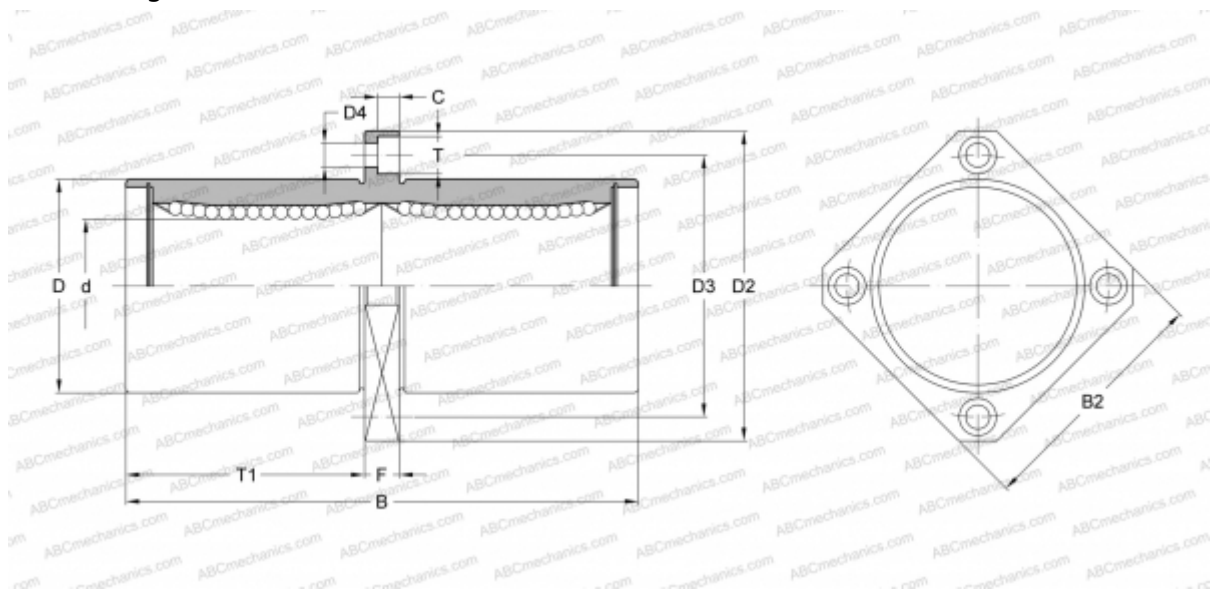

Technical specification

DIMENSIONS, MM

d	8,000
D	15,000
B	45,000
D2	32,000
D3	24,000
D4	3,400
B2	25,000
T	6,500
T1	20,000
C	3,300
F	5

WEIGHT, KG 0,053

MANUFACTURER [SAMICK](#)