

## TK12 UU NB

Linear bushing

TYPE: Shaft guidance systems, Linear bushing, Self aligning, Close type, Type TK (NB)

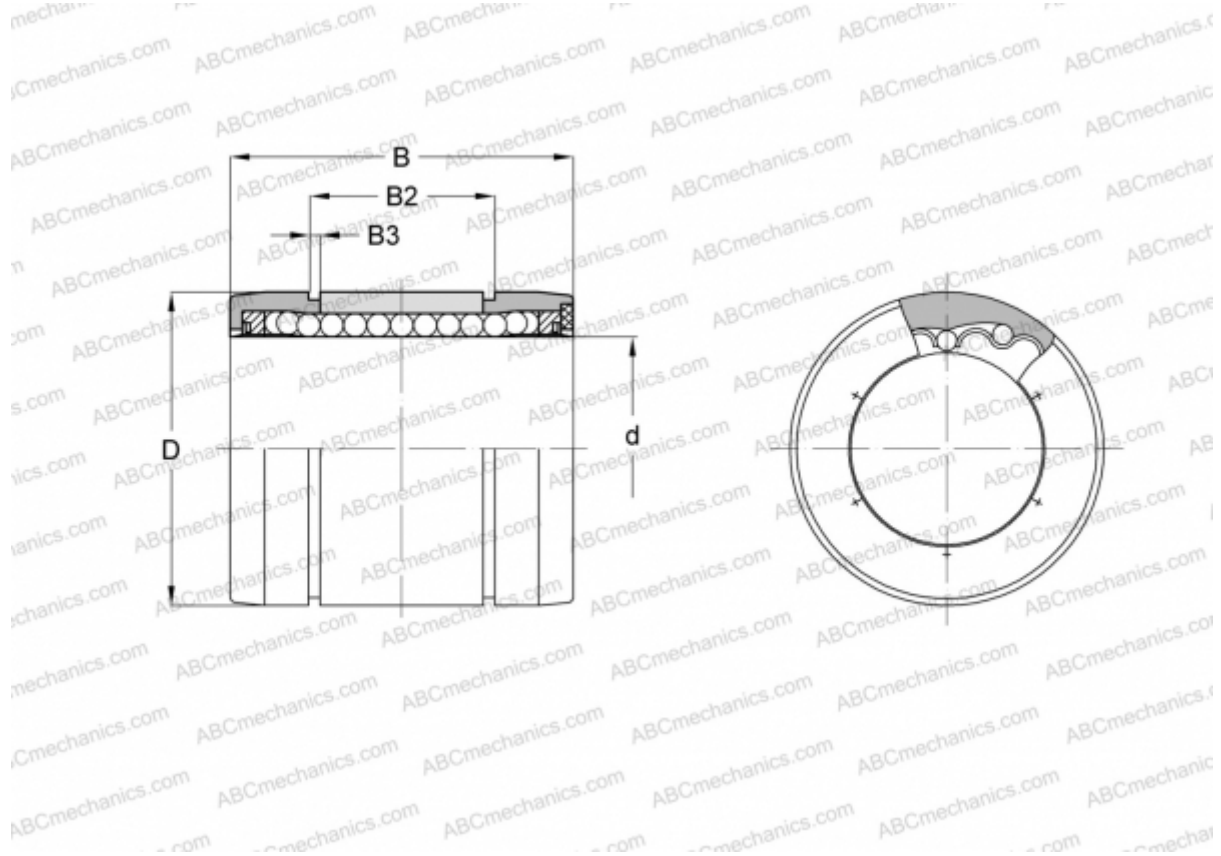

### Technical specification

#### DIMENSIONS, MM

d	12,000
D	22,000
B	32,000
B2	22,900
B3	1,300

**WEIGHT, KG** 0,021

**MANUFACTURER** [NB](#)