

TK40 UU NB

Linear bushing

TYPE: Shaft guidance systems, Linear bushing, Self aligning, Close type, Type TK (NB)

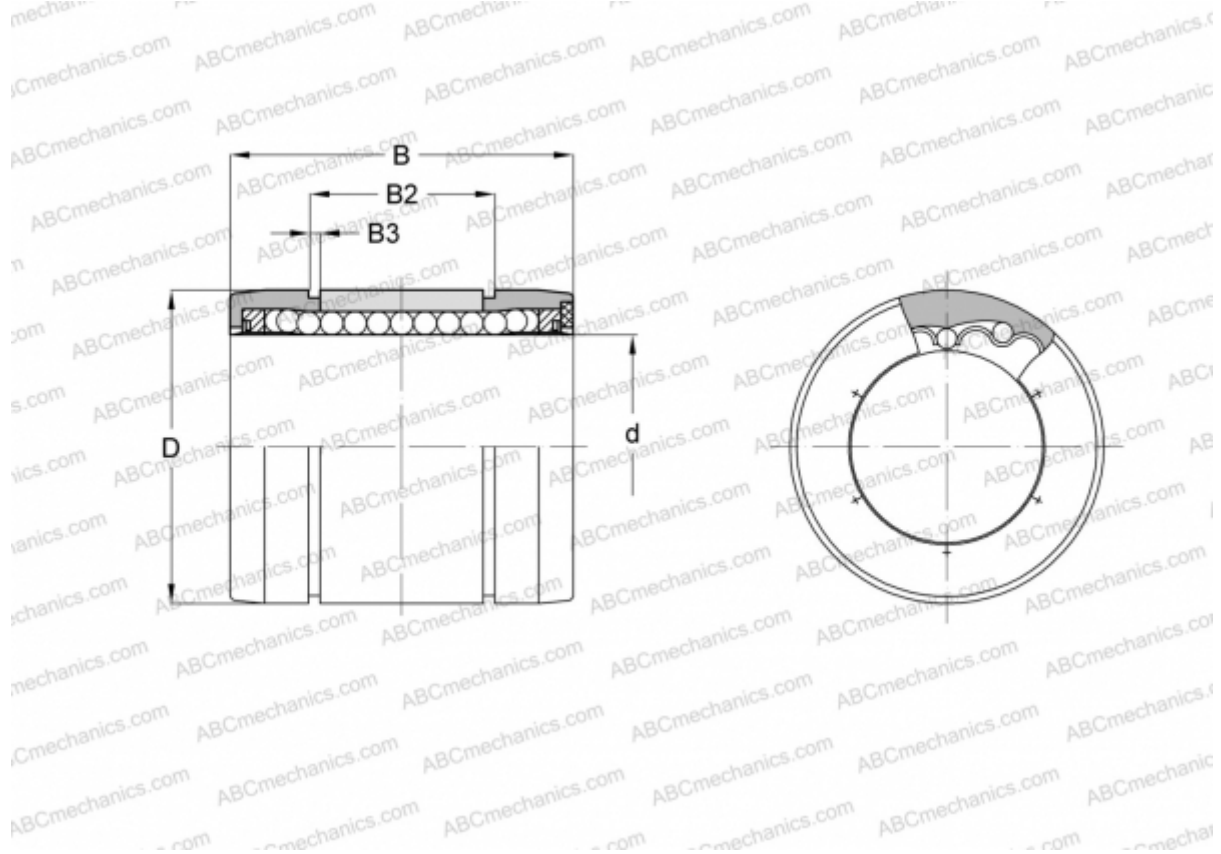

Technical specification

DIMENSIONS, MM

d	40,000
D	62,000
B	80,000
B2	60,600
B3	2,150

WEIGHT, KG 0,333

MANUFACTURER [NB](#)