

TW 4 UU NB

Linear bushing

TYPE: Shaft guidance systems, Linear bushing, Self aligning, Close type, Type TW, inch size (NB)

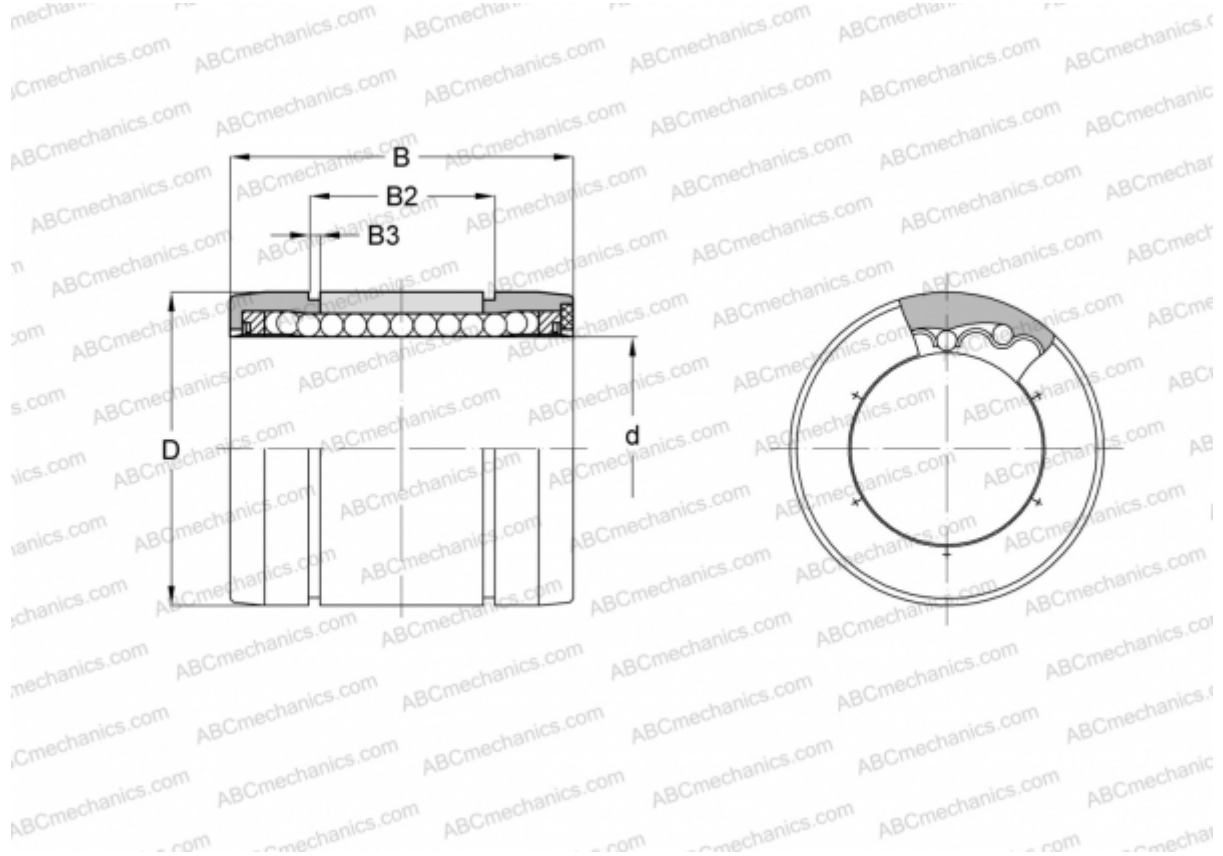

Technical specification

DIMENSIONS, MM

d	6,350
D	12,700
B	19,050
B2	13,081
B3	0,991

WEIGHT, KG 0,004

MANUFACTURER [NB](#)