

TW 6 UU NB

Linear bushing

TYPE: Shaft guidance systems, Linear bushing, Self aligning, Close type, Type TW, inch size (NB)

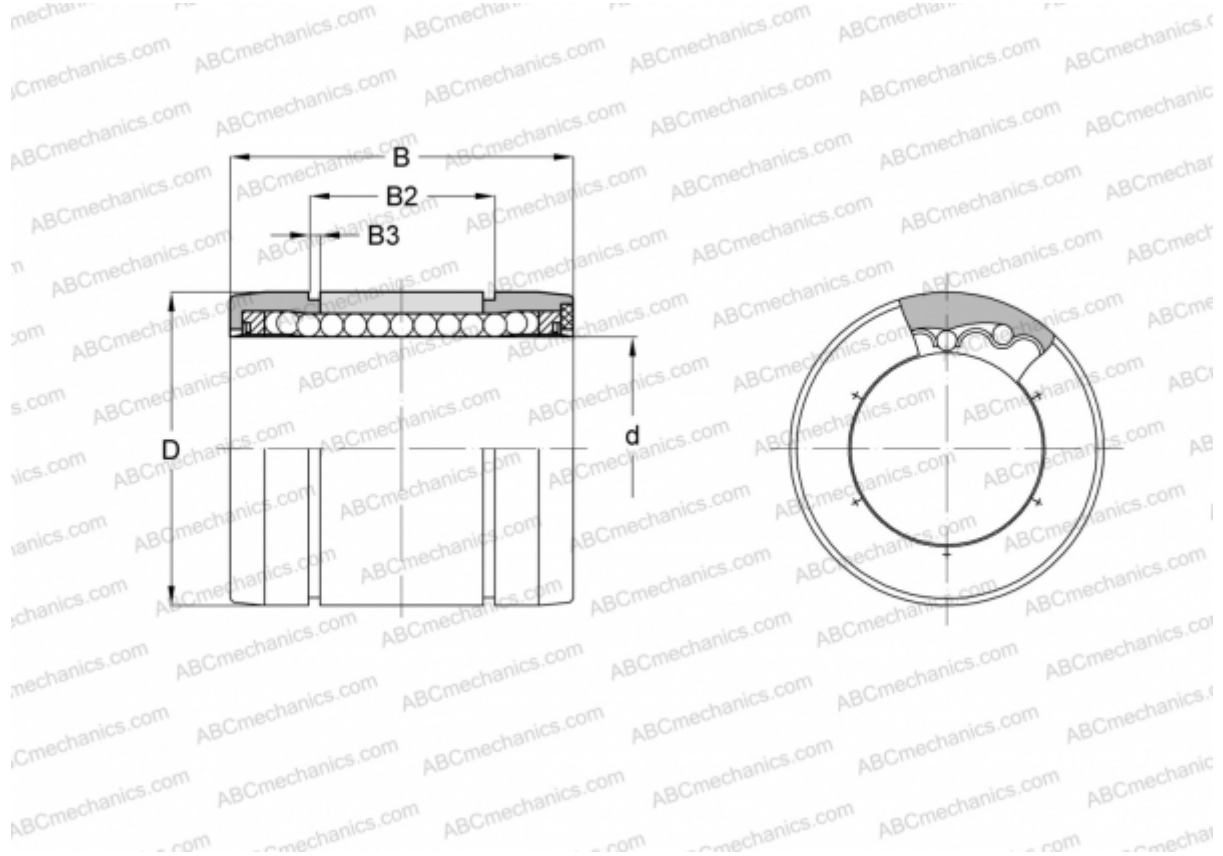

Technical specification

DIMENSIONS, MM

d	9,525
D	15,875
B	22,225
B2	17,856
B3	0,991

WEIGHT, KG 0,006

MANUFACTURER [NB](#)