

TW 16 UU NB

Linear bushing

TYPE: Shaft guidance systems, Linear bushing, Self aligning, Close type, Type TW, inch size (NB)

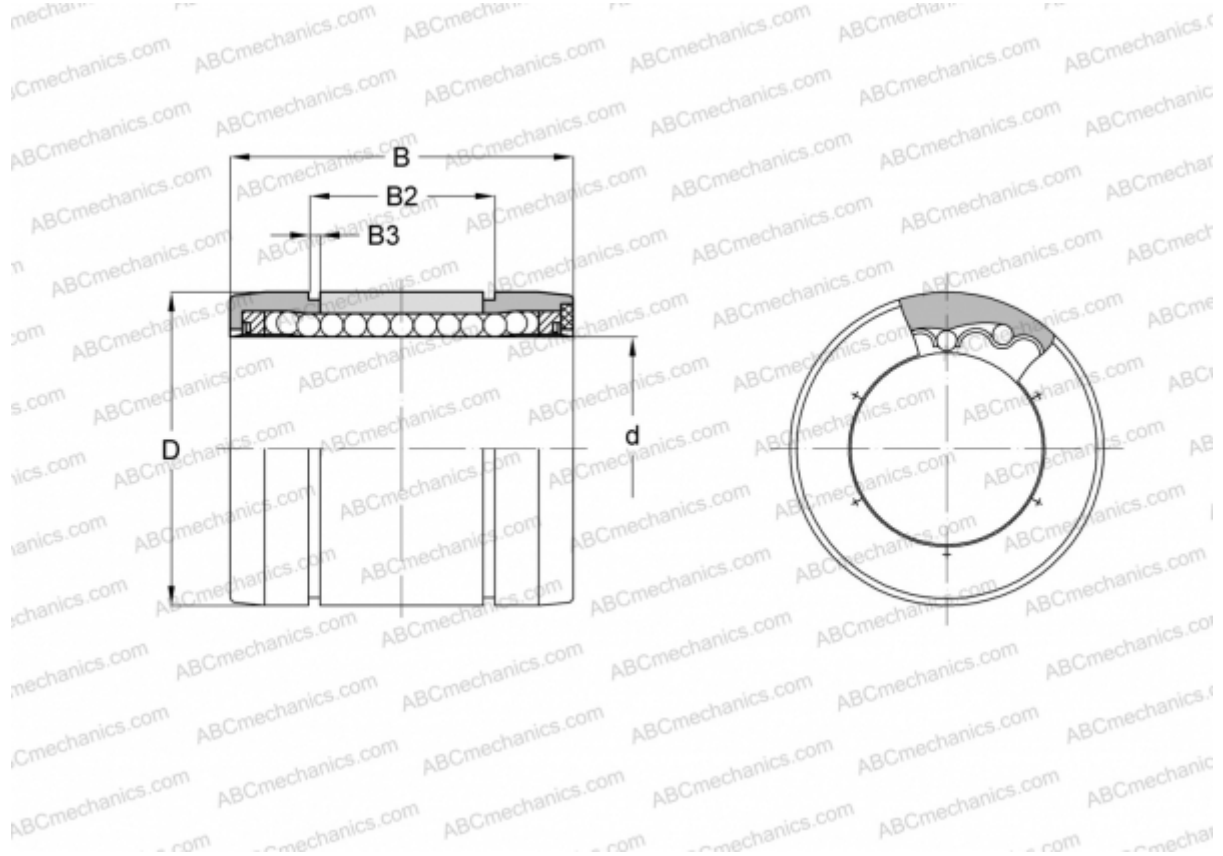

Technical specification

DIMENSIONS, MM

d	25,400
D	39,688
B	57,150
B2	47,904
B3	1,725

WEIGHT, KG 0,120

MANUFACTURER [NB](#)