

## TW 32 UU NB

Linear bushing

TYPE: Shaft guidance systems, Linear bushing, Self aligning, Close type, Type TW, inch size (NB)

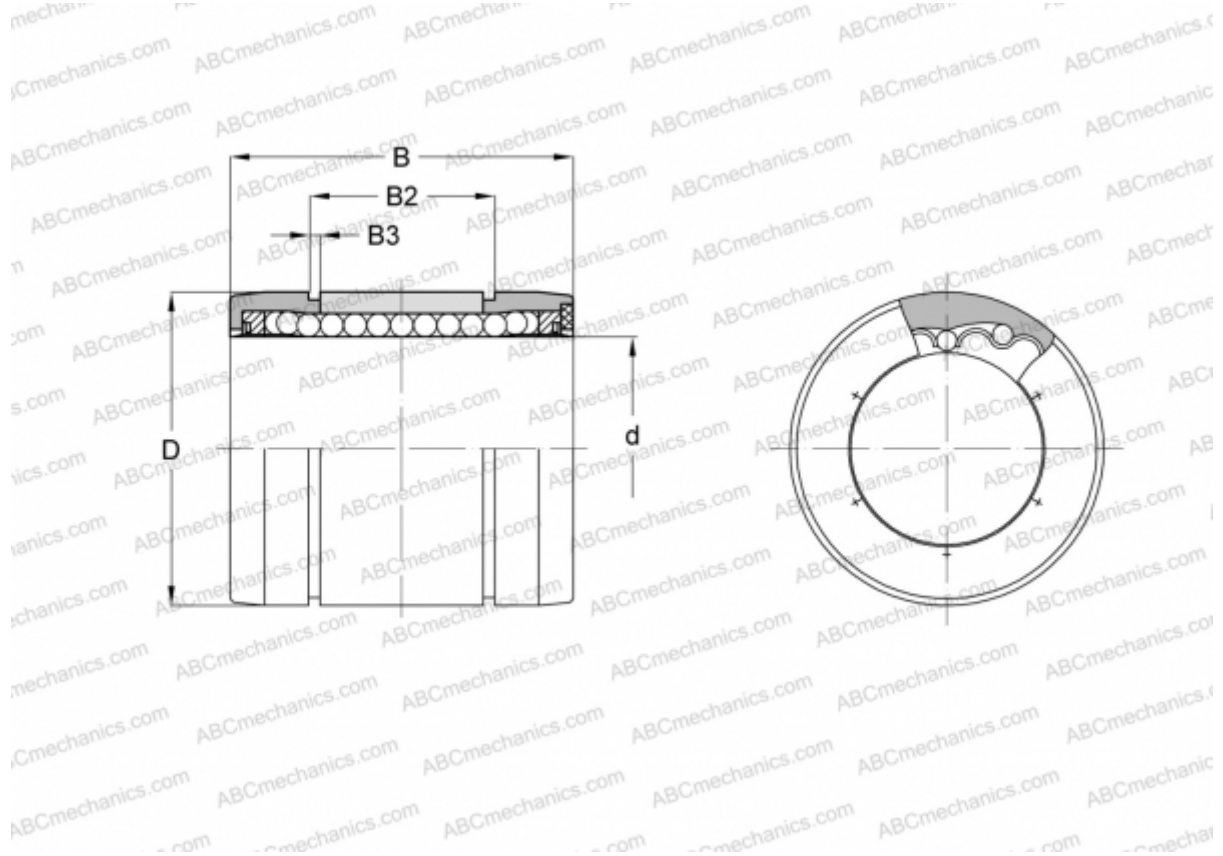

### Technical specification

#### DIMENSIONS, MM

d	50,800
D	76,200
B	101,600
B2	81,432
B3	2,614

**WEIGHT, KG** 0,640

**MANUFACTURER** [NB](#)