

TK16 UU SK NB

Linear bushing

TYPE: Shaft guidance systems, Linear bushing, Self aligning, Close type, Type TK, corrosion resistance (NB)

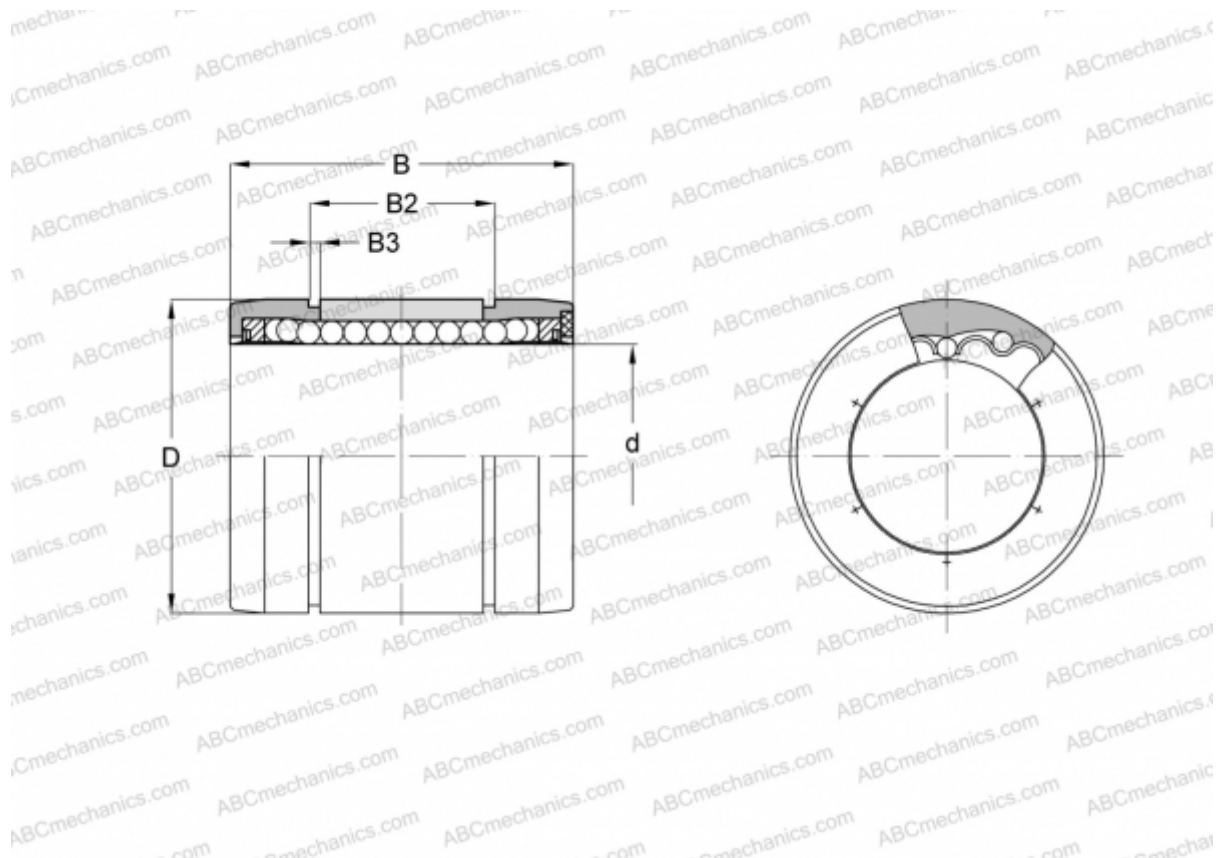

Technical specification

DIMENSIONS, MM

d	16,000
D	26,000
B	36,000
B2	24,900
B3	1,300

WEIGHT, KG 0,043

MANUFACTURER [NB](#)