

TK20 UU SK NB

Linear bushing

TYPE: Shaft guidance systems, Linear bushing, Self aligning, Close type, Type TK, corrosion resistance (NB)

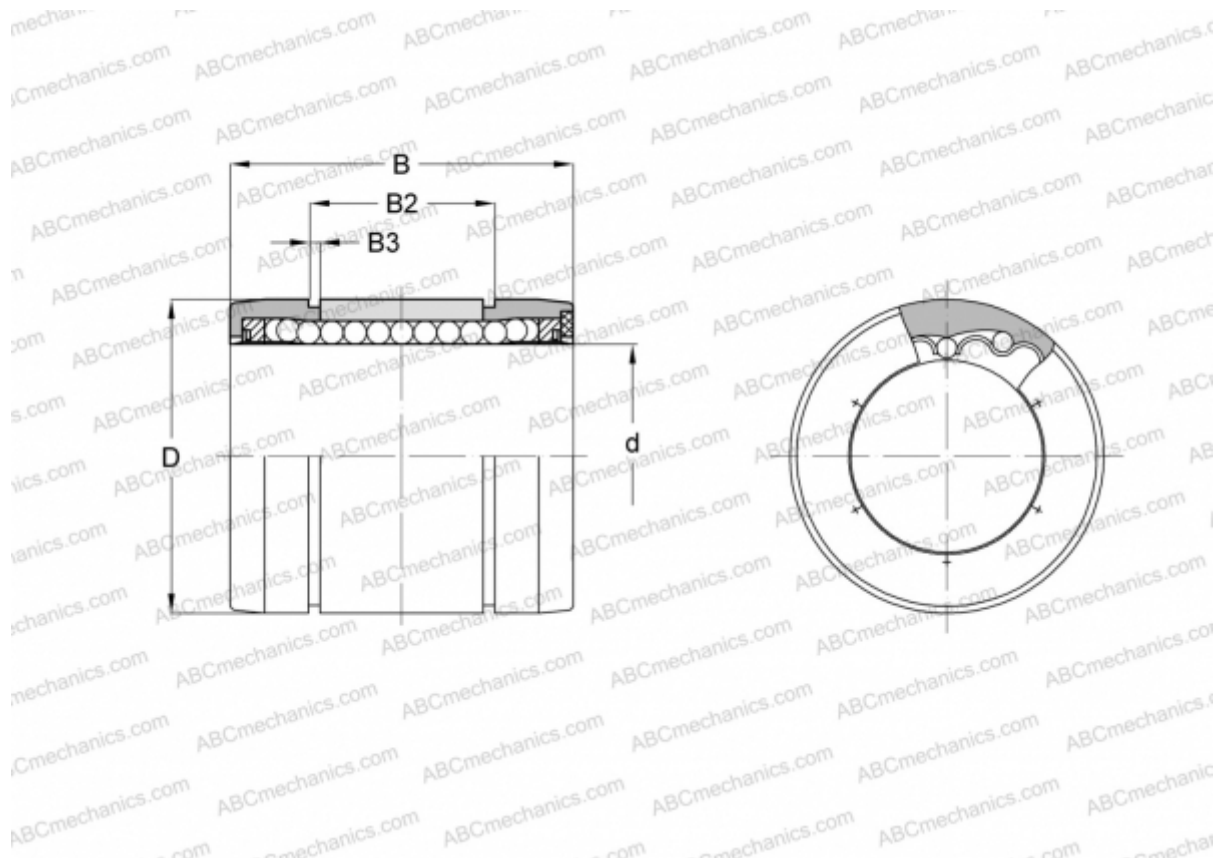

Technical specification

DIMENSIONS, MM

d	20,000
D	32,000
B	45,000
B2	31,500
B3	1,600

WEIGHT, KG 0,058

MANUFACTURER [NB](#)