

TK25 UU SK NB

Linear bushing

TYPE: Shaft guidance systems, Linear bushing, Self aligning, Close type, Type TK, corrosion resistance (NB)

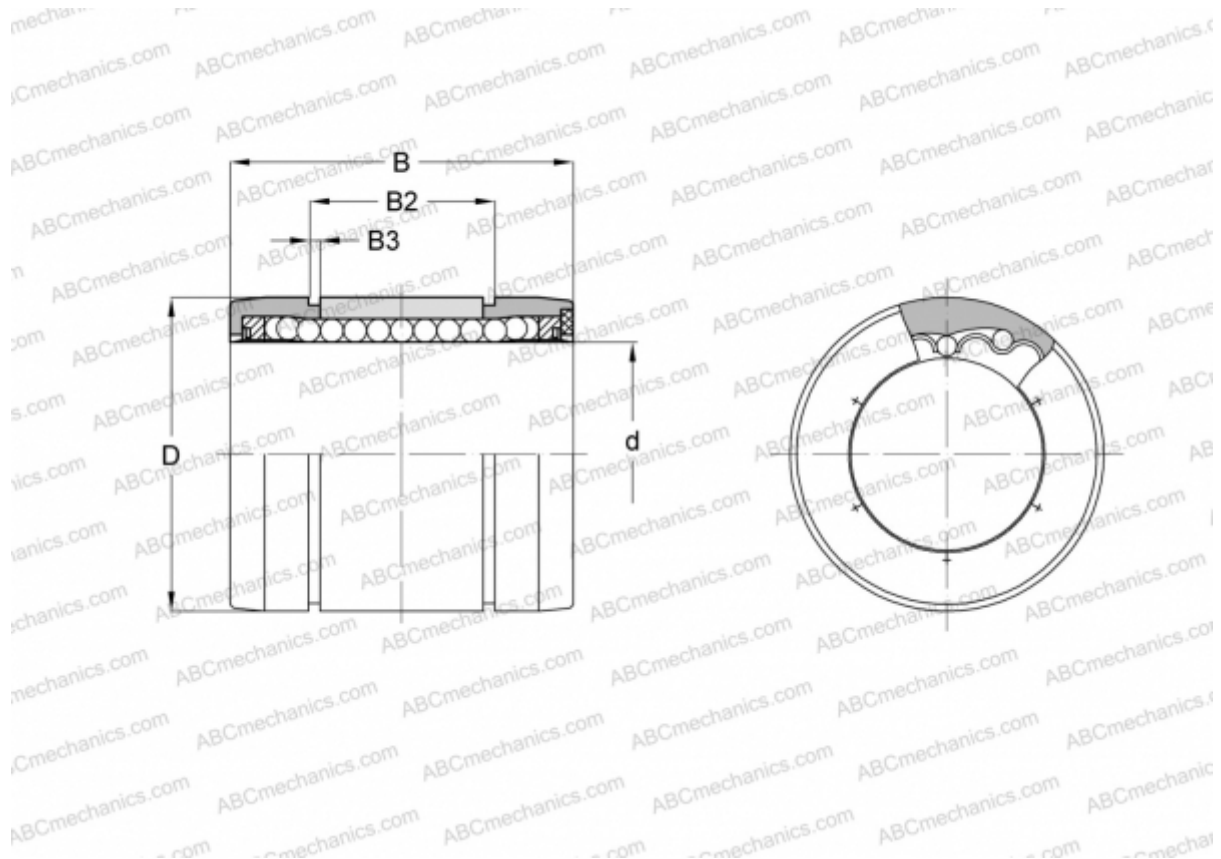

Technical specification

DIMENSIONS, MM

d	25,000
D	40,000
B	58,000
B2	44,100
B3	1,850

WEIGHT, KG 0,123

MANUFACTURER [NB](#)