

TK30 UU SK NB

Linear bushing

TYPE: Shaft guidance systems, Linear bushing, Self aligning, Close type, Type TK, corrosion resistance (NB)

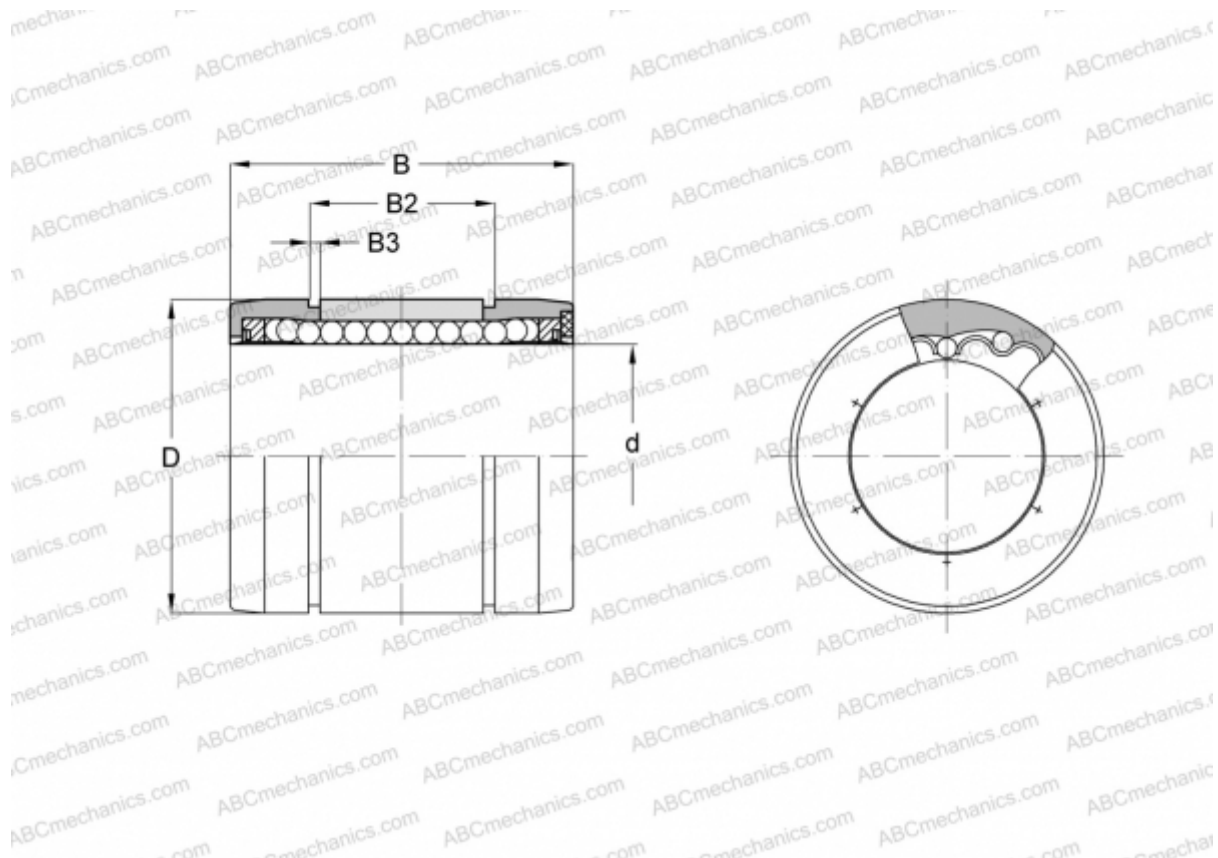

Technical specification

DIMENSIONS, MM

d	30,000
D	47,000
B	68,000
B2	52,100
B3	1,850

WEIGHT, KG 0,216

MANUFACTURER [NB](#)