

TW 10 UU SK NB

Linear bushing

TYPE: Shaft guidance systems, Linear bushing, Self aligning, Close type, Type TW, corrosion resistance, inch size (NB)

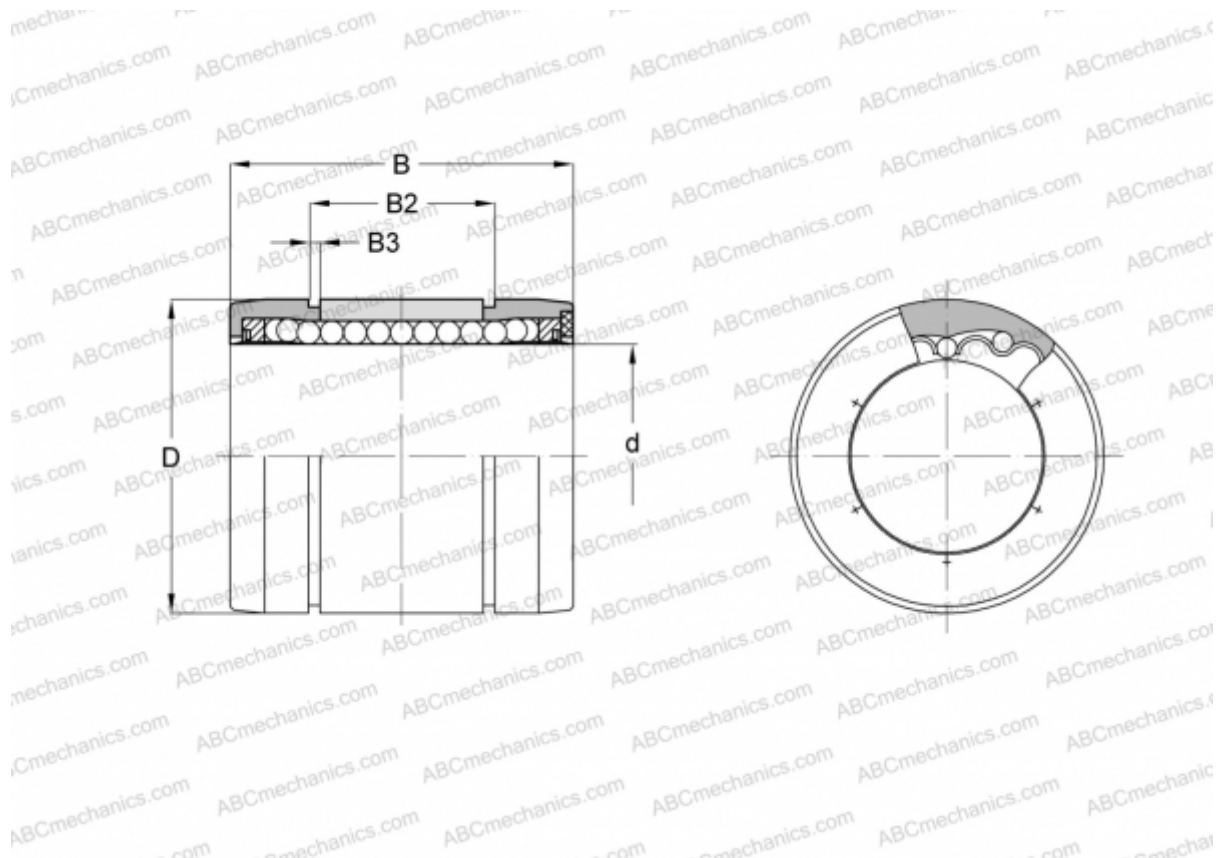

Technical specification

DIMENSIONS, MM

d	15,875
D	28,575
B	38,100
B2	28,245
B3	1,420

WEIGHT, KG 0,047

MANUFACTURER [NB](#)