

TK16 UU OP NB

Linear bushing

TYPE: Shaft guidance systems, Linear bushing, Self aligning, Open type for support rail, Type TK..OP (NB)

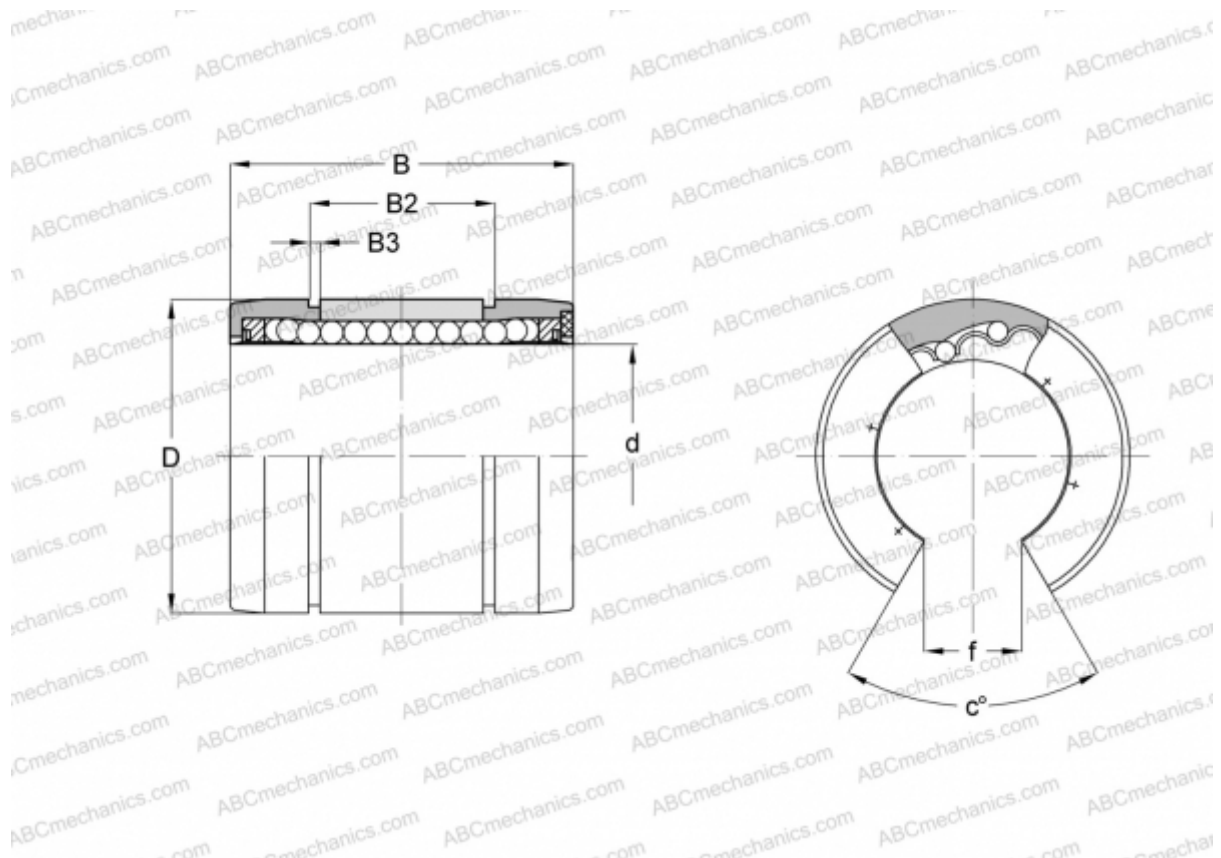

Technical specification

DIMENSIONS, MM

d	16,000
D	26,000
B	36,000
B2	24,900
B3	1,300
f	9,000
c	68

WEIGHT, KG 0,035

MANUFACTURER [NB](#)