

TK20 UU OP NB

Linear bushing

TYPE: Shaft guidance systems, Linear bushing, Self aligning, Open type for support rail, Type TK..OP (NB)

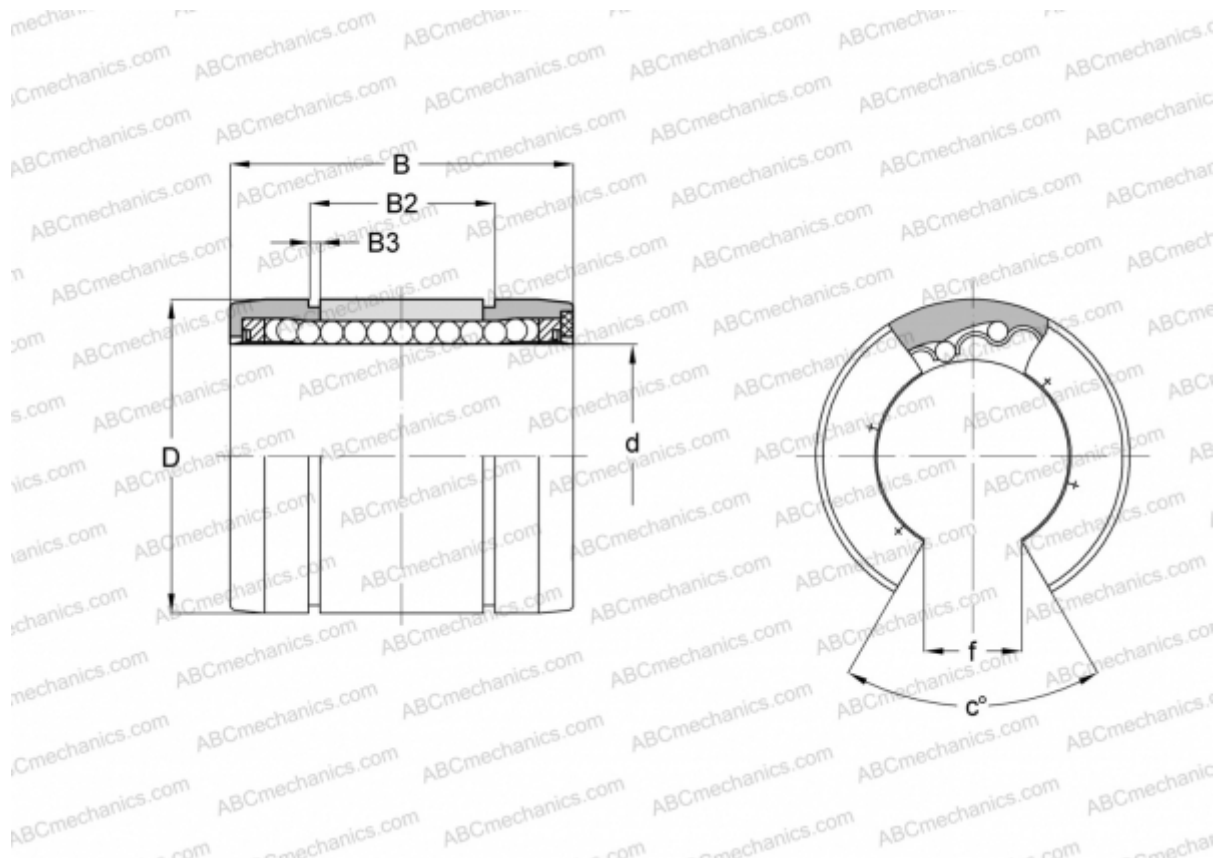

Technical specification

DIMENSIONS, MM

d	20,000
D	32,000
B	45,000
B2	31,500
B3	1,600
f	9,000
c	55

WEIGHT, KG 0,048

MANUFACTURER [NB](#)