

TK30 UU OP NB

Linear bushing

TYPE: Shaft guidance systems, Linear bushing, Self aligning, Open type for support rail, Type TK..OP (NB)

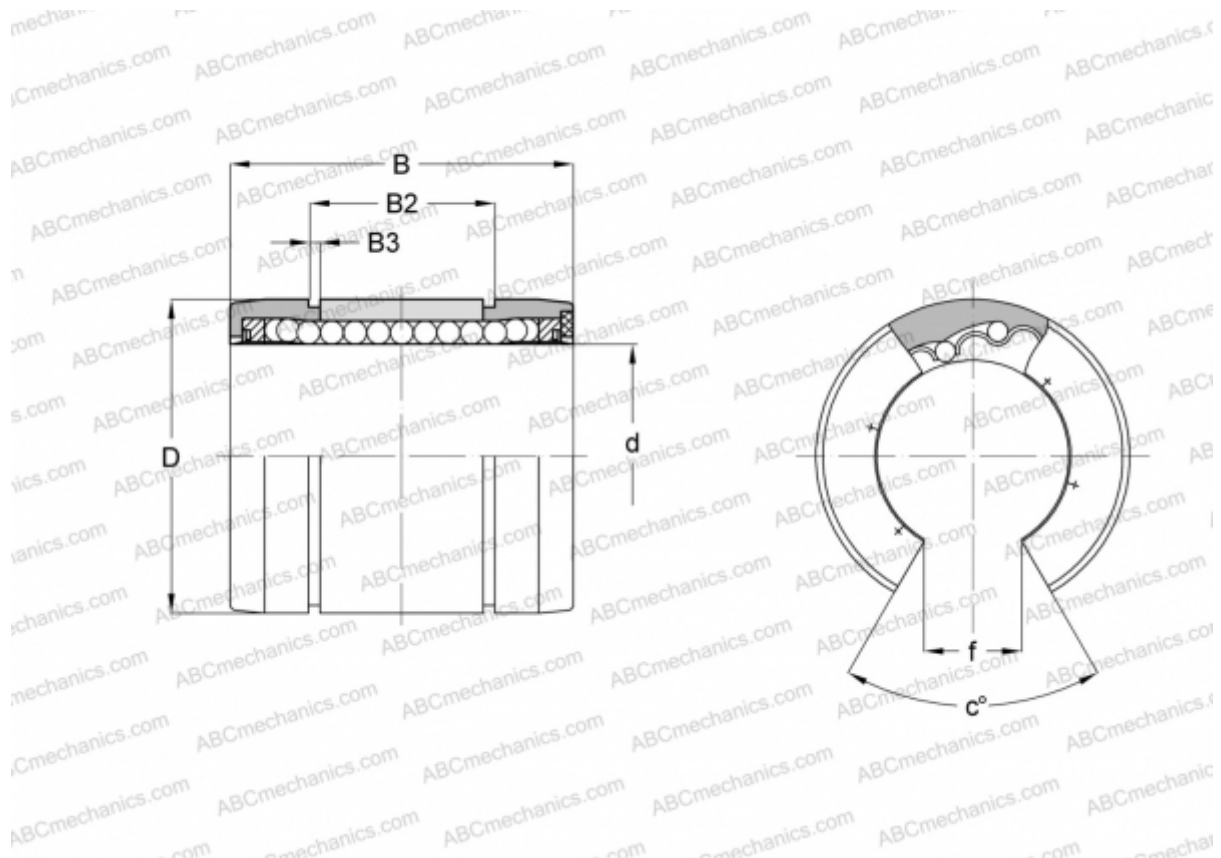

Technical specification

DIMENSIONS, MM

d	30,000
D	47,000
B	68,000
B2	52,100
B3	1,850
f	14,000
c	57

WEIGHT, KG 0,177

MANUFACTURER [NB](#)