

TW 8 UU OP NB

Linear bushing

TYPE: Shaft guidance systems, Linear bushing, Self aligning, Open type for support rail, Type TW..OP, inch size (NB)

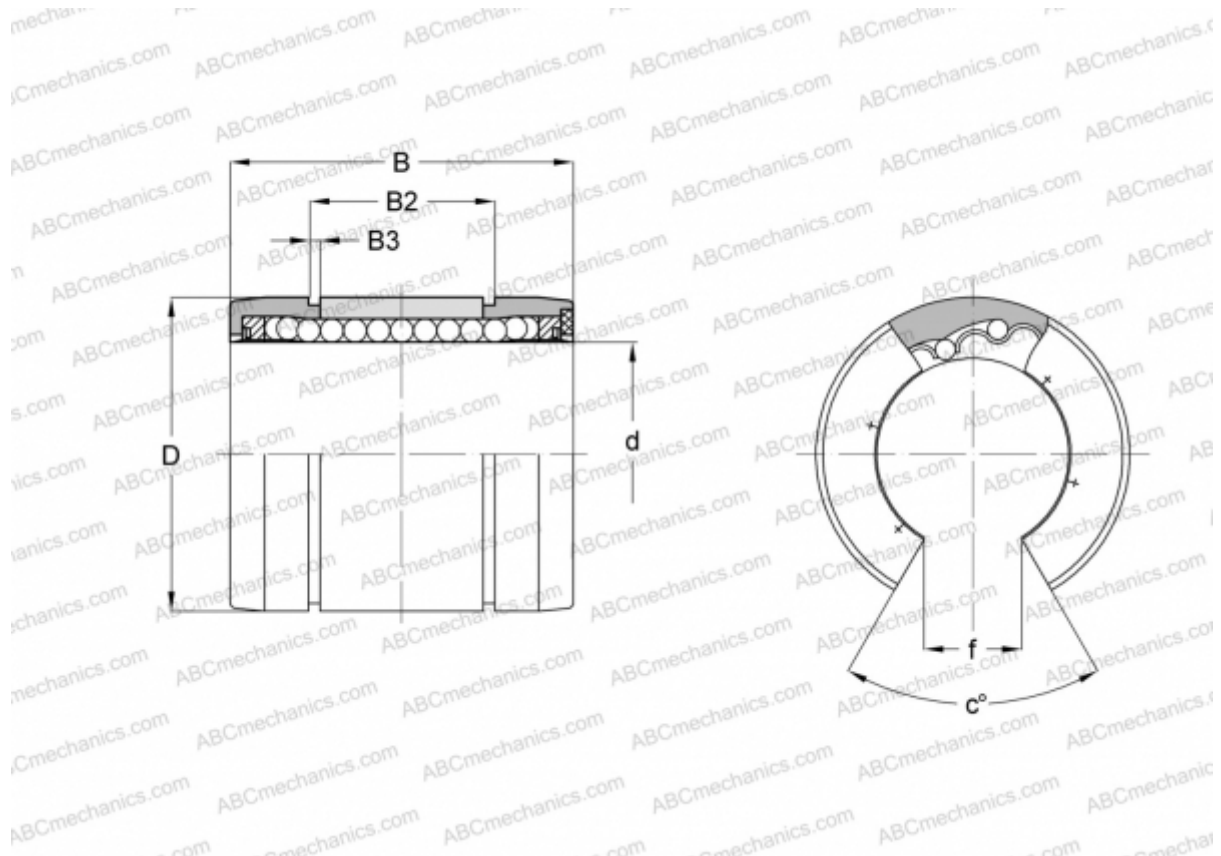

Technical specification

DIMENSIONS, MM

d	12,700
D	22,225
B	31,750
B2	26,213
B3	1,166
f	7,950
c	30

WEIGHT, KG 0,015

MANUFACTURER [NB](#)