

TK12 UU OP SK NB

Linear bushing

TYPE: Shaft guidance systems, Linear bushing, Self aligning, Open type for support rail, Type TK..OP, corrosion resistance (NB)

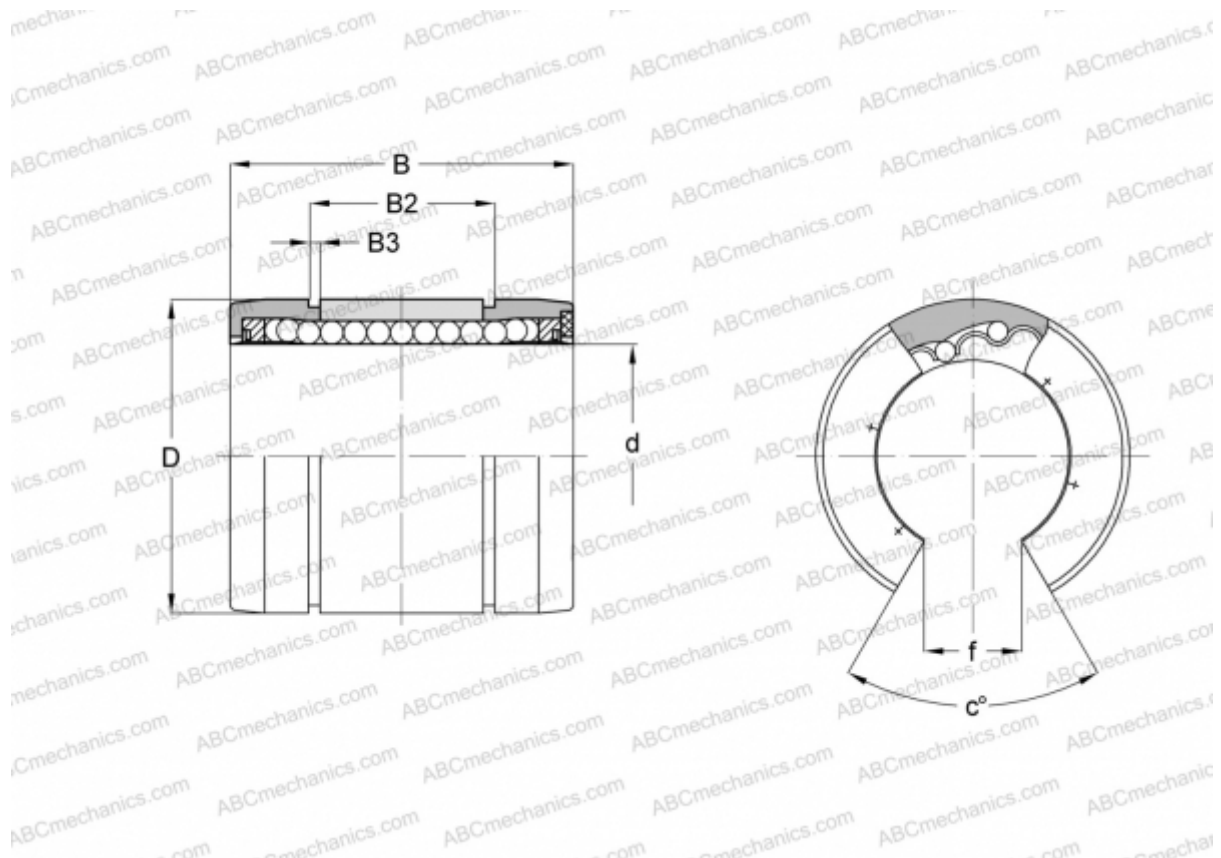

Technical specification

DIMENSIONS, MM

d	12,000
D	22,000
B	32,000
B2	22,900
B3	1,300
f	6,500
c	66

WEIGHT, KG 0,017

MANUFACTURER [NB](#)