

TK40 UU OP SK NB

Linear bushing

TYPE: Shaft guidance systems, Linear bushing, Self aligning, Open type for support rail, Type TK..OP, corrosion resistance (NB)

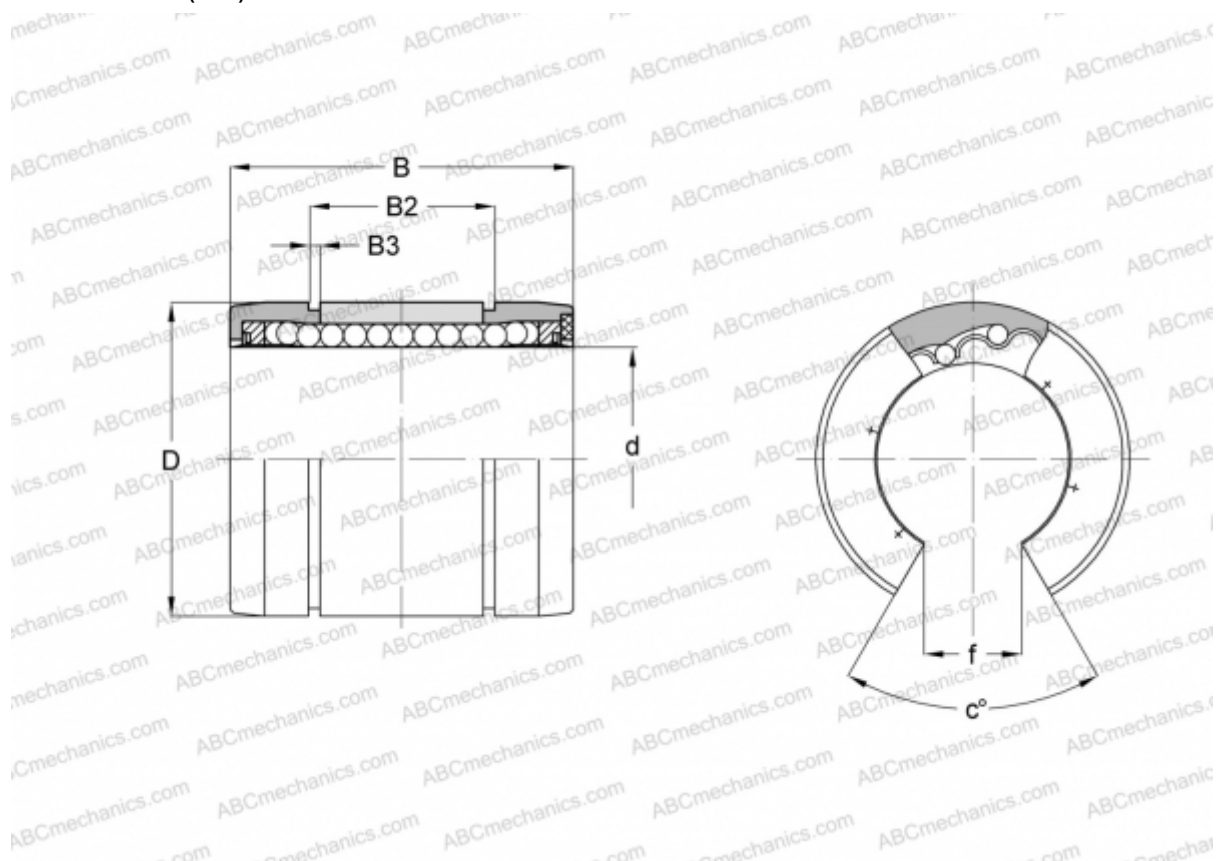

Technical specification

DIMENSIONS, MM

d	40,000
D	62,000
B	80,000
B2	60,600
B3	2,150
f	19,500
c	56

WEIGHT, KG 0,275

MANUFACTURER [NB](#)