

TW 16 UU OP SK NB

Linear bushing

TYPE: Shaft guidance systems, Linear bushing, Self aligning, Open type for support rail, Type TW..OP, corrosion resistance, inch size (NB)

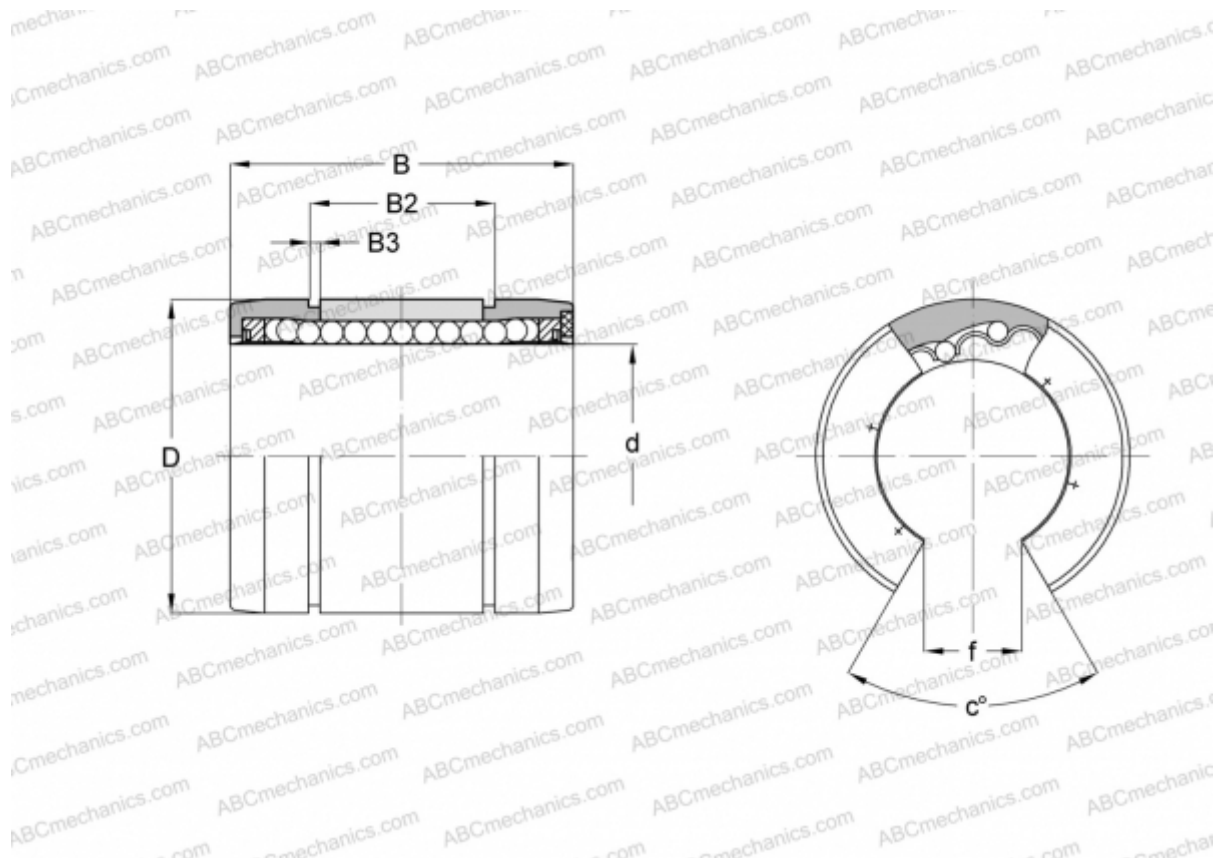

Technical specification

DIMENSIONS, MM

d	25,400
D	39,688
B	57,150
B2	47,904
B3	1,725
f	14,300
c	30

WEIGHT, KG 0,100

MANUFACTURER [NB](#)