

## TW 20 UU OP SK NB

Linear bushing

TYPE: Shaft guidance systems, Linear bushing, Self aligning, Open type for support rail, Type TW..OP, corrosion resistance, inch size (NB)

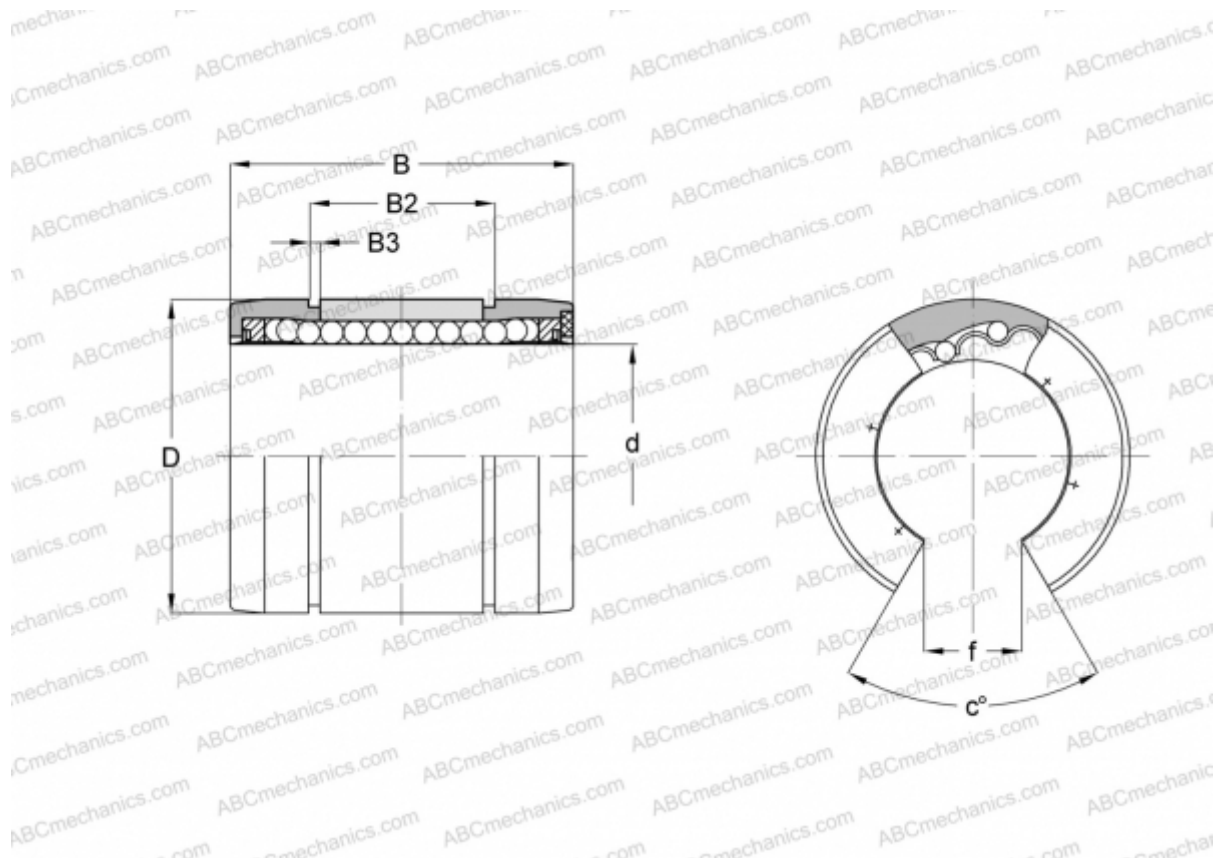

### Technical specification

#### DIMENSIONS, MM

d	31,750
D	50,800
B	66,675
B2	51,079
B3	1,725
f	15,875
c	30

**WEIGHT, KG** 0,190

**MANUFACTURER** [NB](#)