

## TW 24 UU OP SK NB

Linear bushing

TYPE: Shaft guidance systems, Linear bushing, Self aligning, Open type for support rail, Type TW..OP, corrosion resistance, inch size (NB)

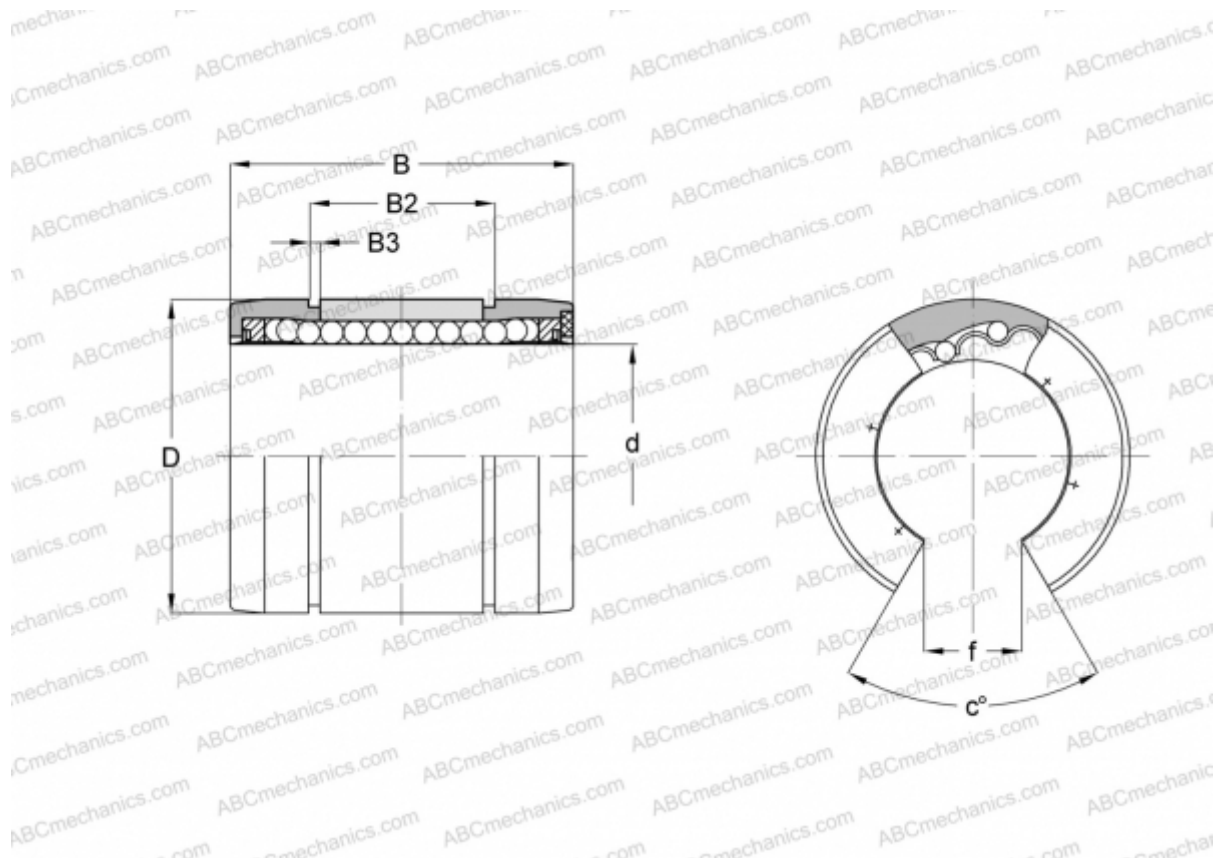

### Technical specification

#### DIMENSIONS, MM

d	38,100
D	60,325
B	76,200
B2	61,519
B3	2,182
f	19,050
c	30

**WEIGHT, KG** 0,290

**MANUFACTURER** [NB](#)