

SMA 4GUU NB

Linear bushing, case unit

TYPE: Shaft guidance systems, Linear bushing, case unit, Close type, Block type, Type SMA, Standart (NB)

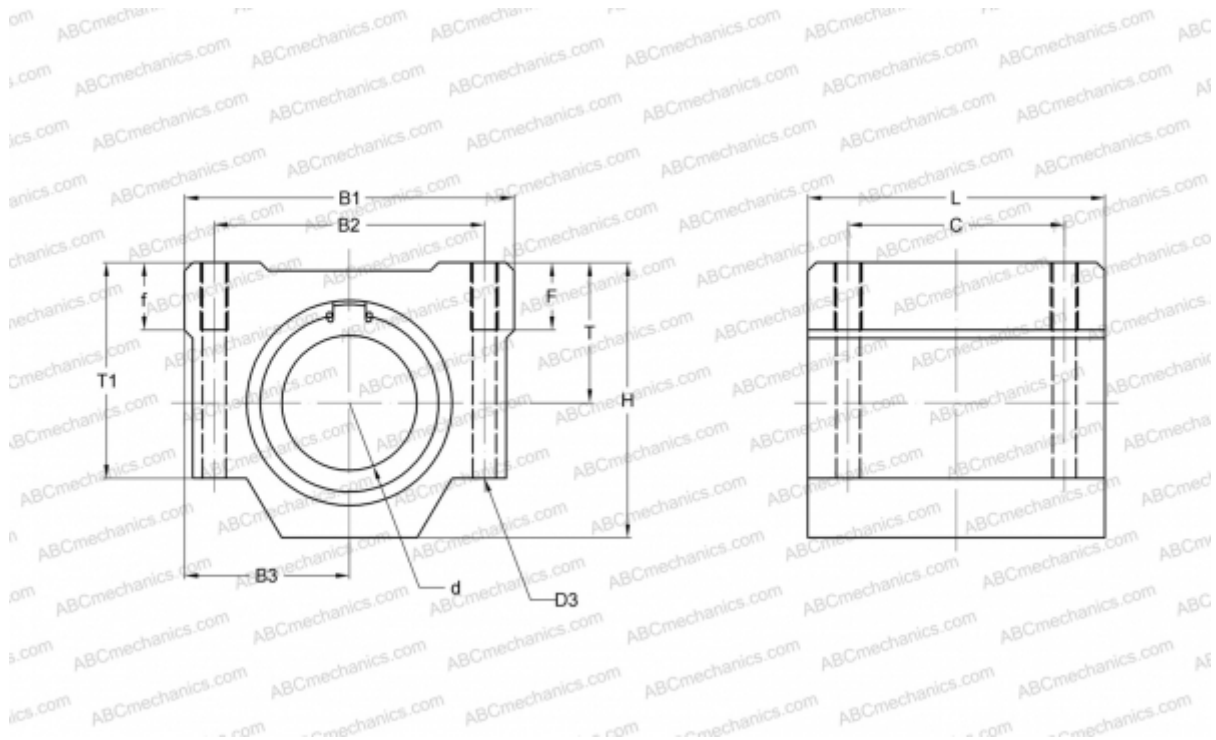

Technical specification

DIMENSIONS, MM

B1	17,000
H	11,000
L	15,000
d	4,000
B2	12,000
B3	8,500
T	5,500
T1	9,000
C	10,000

WEIGHT, KG 0,007

MANUFACTURER [NB](#)