

## SMA12GUU NB

Linear bushing, case unit

TYPE: Shaft guidance systems, Linear bushing, case unit, Close type, Block type, Type SMA, Standart (NB)

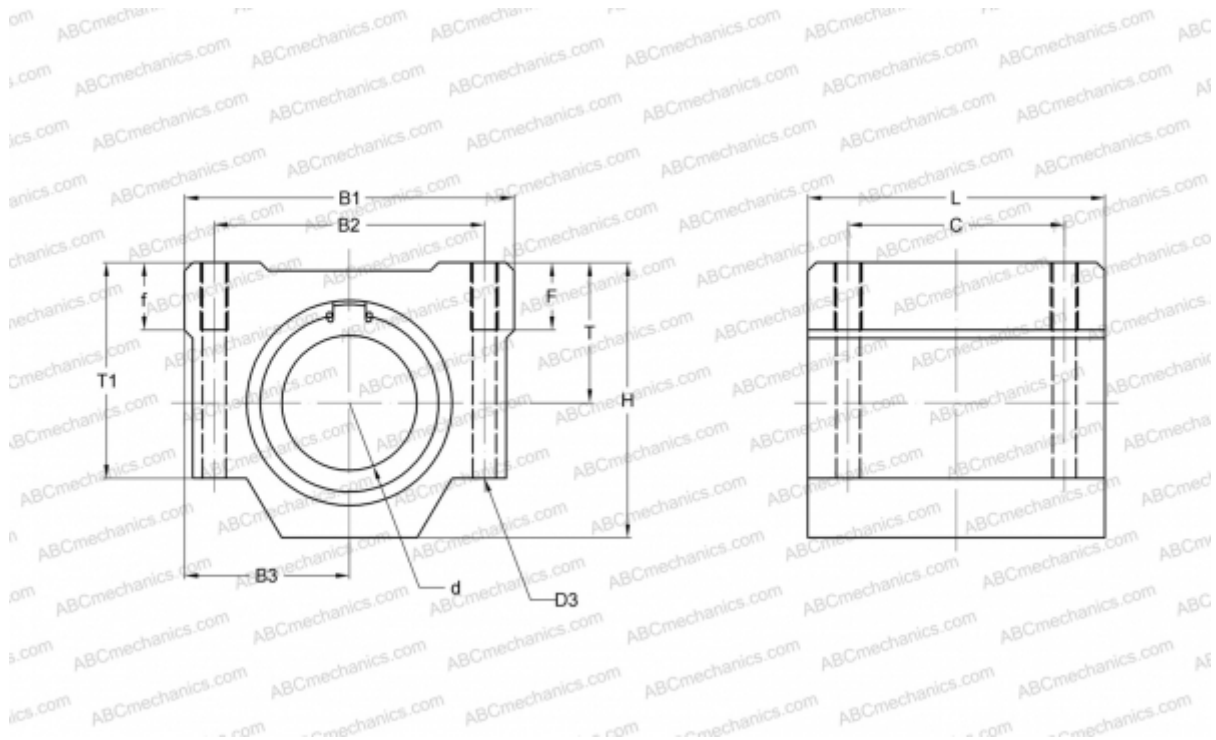

### Technical specification

#### DIMENSIONS, MM

B1	42,000
H	28,000
L	36,000
d	12,000
D3	4,300
B2	30,500
B3	21,000
T	15,000
T1	24,000
f	8,000
C	26,000
F	12

**WEIGHT, KG** 0,102

**MANUFACTURER** [NB](#)