

## SMA50GUU NB

Linear bushing, case unit

TYPE: Shaft guidance systems, Linear bushing, case unit, Close type, Block type, Type SMA, Standart (NB)

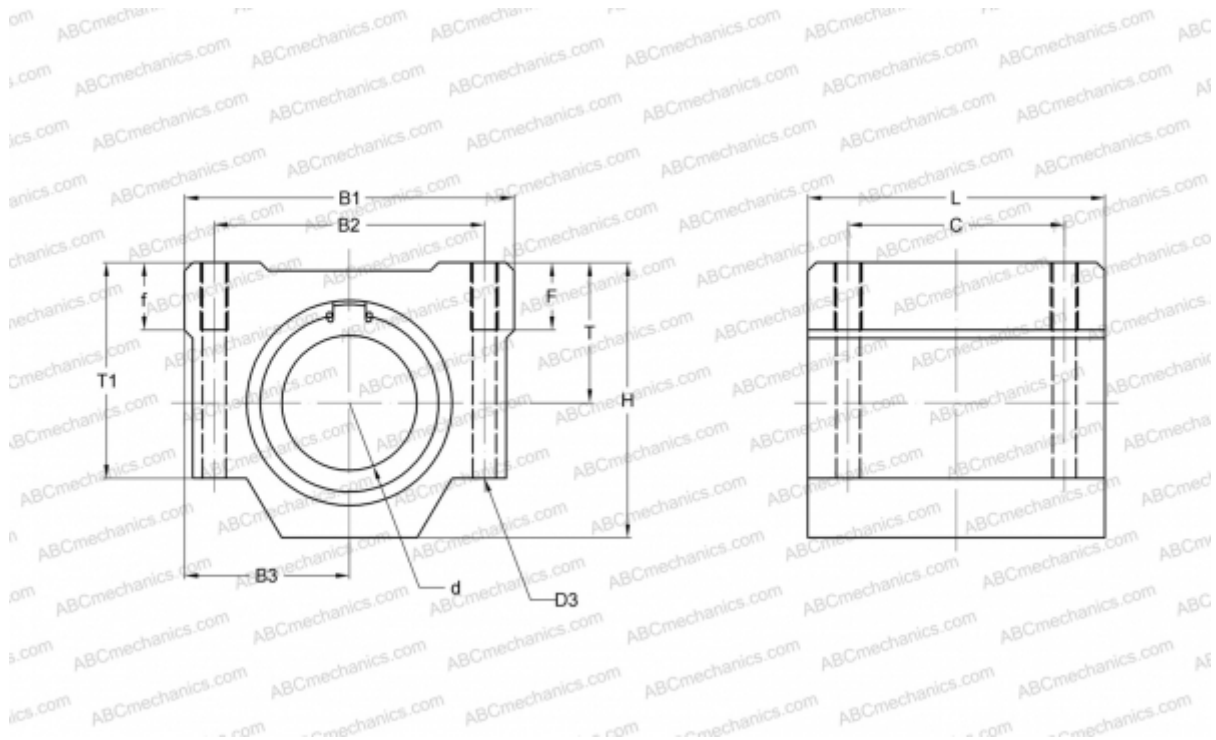

### Technical specification

#### DIMENSIONS, MM

B1	122,000
H	102,000
L	110,000
d	50,000
D3	8,700
B2	100,000
B3	61,000
T	52,000
T1	80,000
f	25,000
C	80,000
F	25

**WEIGHT, KG** 3,340

**MANUFACTURER** [NB](#)